

HUMAN HEALTH

ENVIRONMENTAL HEALTH

IR READY
FOR ANY
CHALLENGE

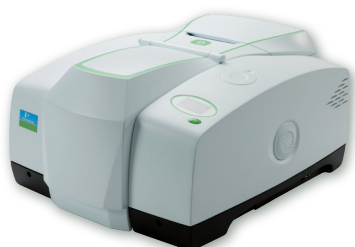

PerkinElmer Frontier
FT-IR, NIR and FIR Spectroscopy



ULTIMATE
PERFORMANCE
UNRIVALLED
FLEXIBILITY



PERKINELMER FRONTIER

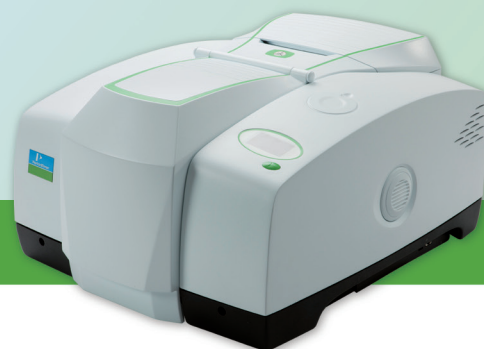

IR READY FOR ANY CHALLENGE

Choose the PerkinElmer Frontier™ range of near-, mid- and far-IR Fourier Transform spectrometers for superior spectroscopic performance in demanding applications.

Powerful and adaptable, the Frontier meets all your current analysis needs and can be expanded as your research goals evolve. And with automated range switching, mid- or far-IR techniques are available at your fingertips. An exceptional signal-to-noise ratio and photometric performance assures optimal spectral performance to ensure best-in-class sensitivity. This configurable platform provides dependable, consistent and trouble-free operation through years of service.

MULTIPLE APPLICATIONS

Frontier can support extensive IR analysis thanks to its superb sensitivity and configurability for optimal results;

Chemicals and Materials

- Develop new products with deeper insight
- Troubleshoot manufacturing problems
- Identify product contaminants
- Confirm quality of materials
- Study advanced material properties, with a wide range of sampling options

Pharmaceuticals

- Gain deeper understanding of product formulations
- Perform counterfeit studies with an array of sampling accessories
- Identify contaminants and impurities in product safety studies
- Rapidly screen ID and quality of raw materials, intermediates and formulated products
- Analyze packaging and package coatings

Research and Academia

- Configure complex experimental set-ups with custom sampling apparatus
- Quickly adapt the flexible platform for multiple research areas or research groups
- Perform far-IR characterization of synthesized materials, semiconductors and novel materials
- Characterize novel laser and detector devices using the configurable beampaths

YOU DEMAND PERFORMANCE

Benchmark-quality results no matter what you measure

- Patented, advanced atmospheric compensation algorithm automatically removes spectral interferences due to H₂O and CO₂ in real time, increasing the reproducibility of spectral data and minimizing purge requirements
- No compromise optical design to provide superb sensitivity, even when using room temperature detectors
- Built-in intelligence to control and monitor measurements, alerting the user to potential analysis errors
- Unique instrument wavelength and line shape standardization using gas phase absorption lines delivers superior accuracy and reproducibility
- Automatic beam geometry control to optimize sensitivity and spectral resolution performance
- Precision-engineered, rugged zero-alignment sampling accessories reduce measurement inconsistencies

Sampling flexibility for today's challenges and those of tomorrow

- An extensive array of smart PerkinElmer and third party modular sample accessories are quickly interchangeable, maximizing instrument uptime
- Hyphenated techniques e.g. TG-IR
- External input and output beam options for custom experiments
- LCD display, go button and Sample Table functionality speeds multiple sample analysis
- Upgradeable optical system to allow upgrades to IR microscopy and imaging, and spectral range upgrades such as mid-IR to mid-near IR dual range systems
- Accommodates multiple detectors (e.g. DTGS and MCT) in optical bench simultaneously to allow rapid and reliable detector switchover

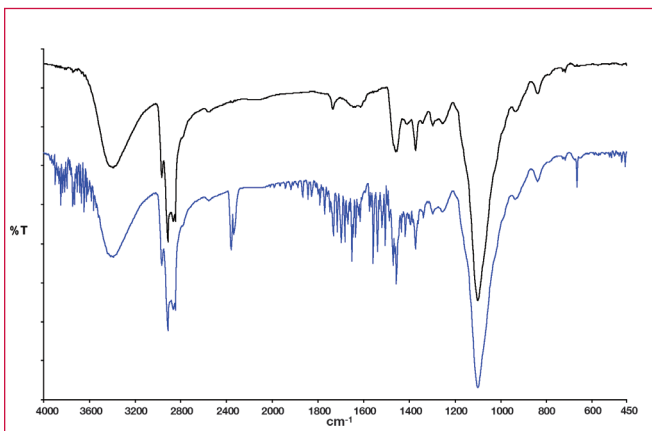

Our unique AVC features an advanced digital filtering algorithm designed to compensate for CO₂ and H₂O absorptions in real time. AVC effectively eliminates interference from these atmospheric components, removing the need for instrument purging, allowing your laboratory to achieve accurate results.

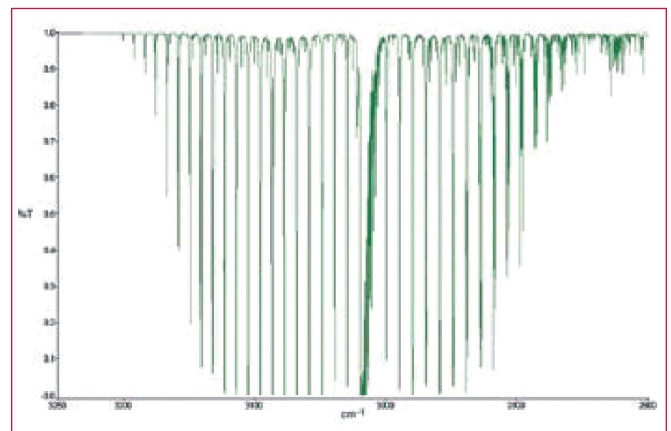

The benefits of high wavelength precision using internal HeNe laser referencing are uniquely extended to wavelength accuracy and line shape using an improved patented gas-phase spectral referencing system – AVI™ Standardization.

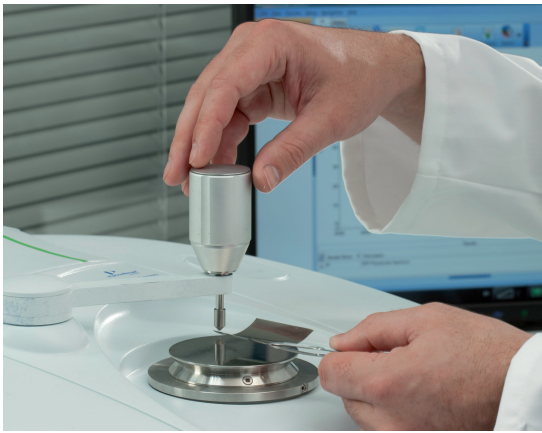

Rapid analysis of new materials

- A range of software tools, library searching and unique COMPARE™ algorithms with sensitive PASS/FAIL threshold setting, allows materials to be identified quickly and easily in the near and mid-IR
- Fast scanning enables reaction kinetics and manufacturing processes to be studied
- High-performance mid- and near-IR imaging options provide rapid characterization of product formulations in a large range of samples including polymers, biomaterials and pharmaceutical formulations
- Simple, powerful AssureID™ intelligent method development and analysis software increases productivity

Powerful product and process troubleshooting

- A wide range of sampling accessories provides the flexibility to measure almost any solid, liquid, powder or paste across the whole mid-/near-IR range
- Choice of high-performance IR microscopes allows identification of tiny impurities in virtually any matrix

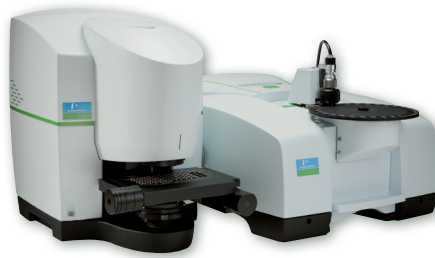

Mid, near or far-IR accessories may be coupled with the Frontier dual range optical benches

Multiple techniques at your fingertips

- Unique automated range switching under software control for fast and trouble-free range changes
- Sources, apertures, optical filters, beam-splitters and beam switching under fully motorized control to ensure repeatable reconfiguration
- Optimized NIR reflection and MIR ATR sampling can be installed simultaneously to increase productivity

Reliability for peace of mind

- Fixed mirror-pair (Dynascan™) interferometer design is immune to the effects of tilt and shear present in commercial instruments; this requires no dynamic alignment mechanisms
- Field-proven, fifth generation interferometer design incorporates a simple, non-critical bearing for unmatched longevity and reliability
- Electronically stabilized source hot spot increases long-term measurement and system alignment stability

CHOOSE YOUR DETECTION RANGE

The PerkinElmer Frontier systems offer superior spectra in the near, near-mid, mid, mid-far and far infrared regions.

Factory-fitted or upgraded as application needs change, the unique automated range changing capability allows multiple techniques to be used at the touch of a button. The flexible, fully upgradeable optical system allows configuration of multi-range, microscopy and imaging systems. Only a single switch is required between macro, micro and image analysis – allowing users to concentrate on the science rather than spectrometer set-up.

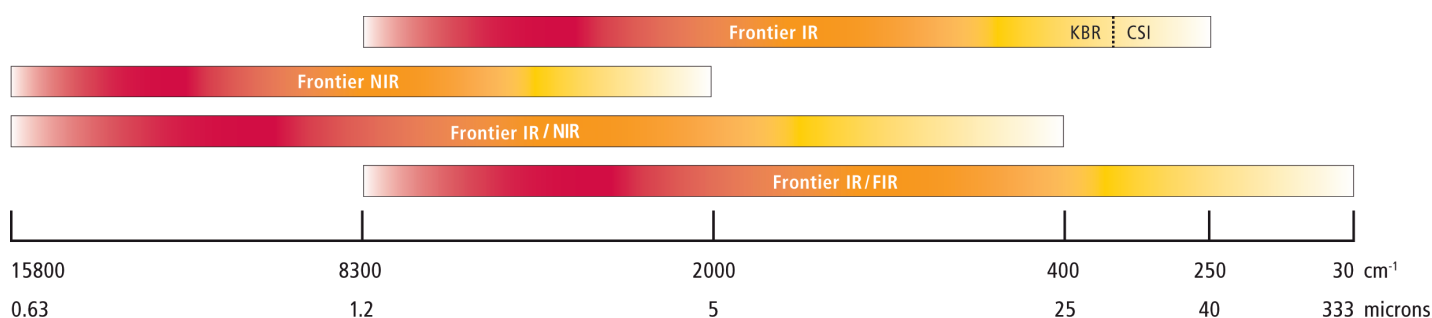

Frontier IR/NIR system with Spotlight imaging and tablet transmission sampling: Pharmaceutical tablet conformity testing



Frontier NIR system with fiber optic sampling: Raw materials identification

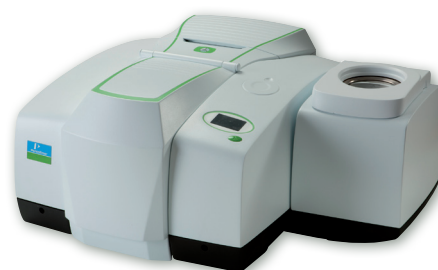

Frontier IR/NIR with NIR reflection and rotating sample holder: Moisture content in foods

Choose your Frontier configuration*

Frontier IR	The industry standard in laboratory IR
Frontier NIR	For high-performance NIR testing
Frontier Optica	A unique instrument designed for optical filter measurements requiring the highest ordinate accuracy
Frontier MIR/NIR	A single optical bench combination of all the benefits from the Frontier mid- and near-IR systems
Frontier MIR/FIR	A full-featured FT-IR system with advanced far-IR capability

*further configurations for specific applications

DUAL-RANGE INSTRUMENTS



PerkinElmer Frontier IR/NIR systems

Dual range for optimized method development and materials testing

Frontier IR/NIR provides unique mid-IR and near-IR dual range performance from a single instrument. Comparing methods on a common platform aids selection of the most suitable sampling techniques and measurement conditions for a particular application.

Automated set-up and range switching enables you to quickly move on to your next sample without manual reconfiguration. In turn, this increases your laboratory productivity and eliminates the need to purchase two instruments, saving valuable bench space and reducing training requirements.

System benefits:

- Faster method development
- Effective comparison of sampling techniques and measurement conditions
- Reduced instrument costs

PerkinElmer Frontier IR/FIR

Flexible and expandable performance for advanced industrial and research laboratories

Extend your IR capabilities into the FIR region using a single optical bench. The automatic beam-splitter changeover delivers a new level of simplicity for far-IR measurements. The built-in system flexibility is perfectly suited to demanding research environments where experiments require customized components.



System benefits:

- Excellent performance over the ca. 700-30cm⁻¹ region due to high-performance interferometer with dedicated multilayer FIR beam-splitter
- Purge stabilization time minimized as high-efficiency, independent purge systems utilized in interferometer and sample area
- Fast, easy switch from mid-IR to far-IR operation as a result of the fully motorized beam-splitter and detector changeover system

FRONTIER SAMPLING SYSTEMS

Whatever your sample, there is a Frontier solution that can be customized to meet your specific needs.

Offering more sampling options than any other FT-IR spectrometer, PerkinElmer Frontier's optical flexibility enables the addition of a vast array of specialized sampling accessories.

Multiple applications can be addressed using a single instrument by simply switching the sampling accessory. Optimized smart, zero-alignment PerkinElmer accessories can be quickly interchanged to create the configuration of choice and maximize instrument uptime. In addition, an extensive range of third party accessories are available to meet additional requirements such as heatable sampling systems and gas cells.

1 Solids autosampler NIR

- 30-position autosampler for tablets or powders
- Patented custom mold provides optimum reproducibility
- Transmission and reflectance modes enable full tablet characterization

2 Diffuse reflectance IR FIR

- Simple analysis of powders and difficult to measure solids
- Range of sampling tools to aid sample preparation
- Automatic sample positioning for improved measurement sensitivity

3 Liquid sipper NIR IR

- Automatic sampling eliminates manual cell-filling
- Contamination check using built-in software reduces analysis error
- Range of cell window materials and pathlengths available

4 HATR IR

- Automatic recognition of top-plate crystal material, angle and serial number
- Displays sample application force to ensure reproducibility of analyses
- Wide range of optional top-plate materials and angles of incidence available



5 TG-IR interface IR

- Hyphenated technique; FT-IR and thermo-gravimetric analysis
- Analyzes breakdown products from decomposition and combustion
- Unique gas transfer system ensures high sensitivity and minimum sample contamination

6 & 7 NIRA NIR IR

- Measures solids, liquids, powders, gels and pastes within containers, such as blister packs, polythene bags and glass vials
- NIR reflection and transfection requiring no manual sample preparation
- Self-referencing (interleaved) functionality increases reproducibility and ease of use

8 UATR IR

- Universal sampling for simple IR spectroscopic analysis
- Automatic recognition of top-plate crystal, number of reflections and serial number for traceability
- Unique kinematic top-plate mounting and electronic force gauge ensure optimum reproducibility
- Multiple replaceable sample top-plates for ultimate flexibility

9 Remote liquids probe NIR

- Remote transmission measurement of liquids allows direct measurement within reaction vessels
- Universal interface ensures compatibility with a wide range of probes
- Design facilitates rapid and easy decontamination
- Electrically safe for use in hazardous environments

10 Remote solids probe NIR

- Sampling of powders or solids up to 10 meters away from instrument
- Advanced handset with scan trigger and LCD interface allows continuous remote operation
- Design facilitates rapid and easy decontamination
- Electrically safe for use in hazardous environments
- ATEX compliant



SPECIALIZED APPLICATIONS

The inherent optical flexibility of the PerkinElmer Frontier means we can offer a unique selection of specialized accessories, in addition to standard sampling options.



Polarized UATR

- UATR with adjustable polarizer
- Powerful tool for structure determination, teaching fundamentals of IR spectroscopy and understanding crystal- and polymer-chain orientation
- Ideal for food and pharma packaging and nanomaterial analysis



Input beam

- Sample measurement by emission
- Characterization of external sources
- Pre-interferometer sampling
- Remote infrared telescopic measurement

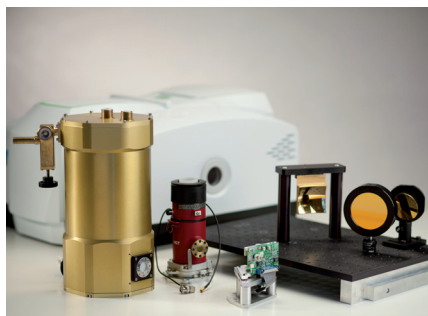

General-purpose optical bench

- Designed to accommodate large or specialized sampling systems, such as cryostats and high-vacuum accessories
- Detector characterization
- Measurement using custom detectors

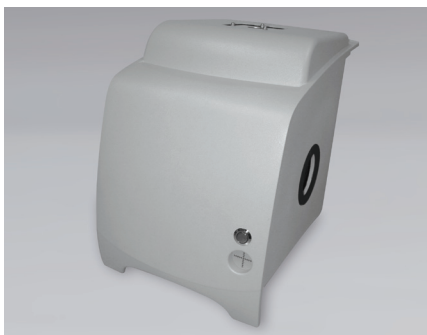

IR specular reflection set

- Measures IR emissivity of architectural glass to EN standards
- Accommodates large sample sizes
- Includes pre-calibrated, traceable reflection standards and emissivity calculation software



Cryogenic measurements

- Sample compartment configurable for third party cryostats
- Far-IR operation for advanced materials and semiconductor research



Far-IR ATR

- All diamond ATR systems for convenient far-IR sampling
- Rapid IR-FIR switchover
- Rapid, efficient purge operation for faster measurement
- Ideal for measurement of inorganic material



TL8000 TG-IR interface

- Designed for high performance and reliability
- Wide temperature range
- Robust transfer line
- Balanced gas flow design for improved flow regulation gas component resolution
- Ideal for characterization of bioenergy materials, polymer performance measurements and residual solvent analysis

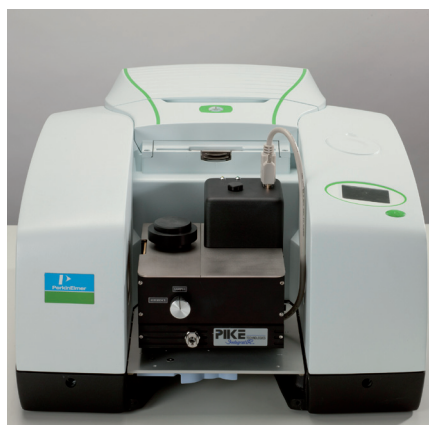

Integrating sphere measurements

- Mid-IR integrating sphere
- Reflection and transmission sampling
- Dedicated detector for high performance sampling

SETTING THE STANDARD

The Frontier optical bench is loaded with a range of advanced innovations designed to provide optimal performance from the configuration you choose, day in, day out.

User-replaceable and electronically-stabilized source

Unique electronic hot-spot stabilization increases measurement stability and extends source lifetime

Beam-splitter changing mechanism

Automatic switching between the IR and NIR or FIR beam-splitter without manual user intervention

Microscopy and imaging upgrade capabilities

Installation of automated switching directs beam into any PerkinElmer microscopy or imaging system

Dual-source mechanism

Fast IR to NIR switchover at the touch of a button

Atmospheric Vapor Compensation™ (AVC)

AVC features an advanced digital filtering algorithm designed to compensate for CO₂ and H₂O absorptions in real time. AVC effectively eliminates interference from these atmospheric components, removing the need for instrument purging, allowing your laboratory to achieve more consistent results.

Variable J-stop

Limits beam divergence to provide optimal measurements at all resolutions, including intermediate settings, unlike fixed J-stops

Absolute Virtual Instrument™ (AVI)

AVI standardization using gas phase spectra ensures your instruments are accurately calibrated. The instrument's wavenumber and line shape are standardized to a higher degree of accuracy than with conventional calibration methods. This unique standardization allows data to be transferred precisely between instruments, whether they are side-by-side or in remote locations.

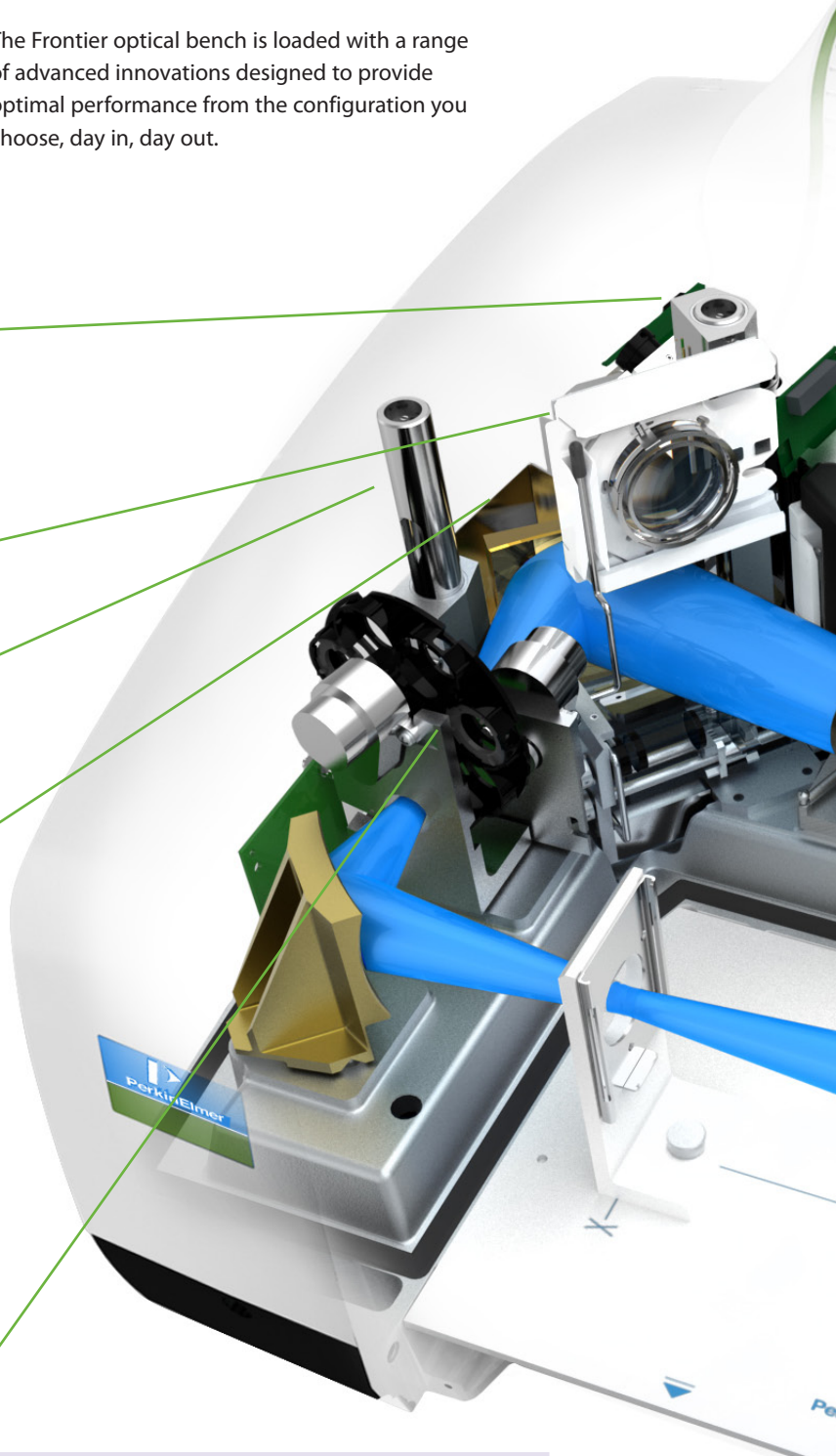

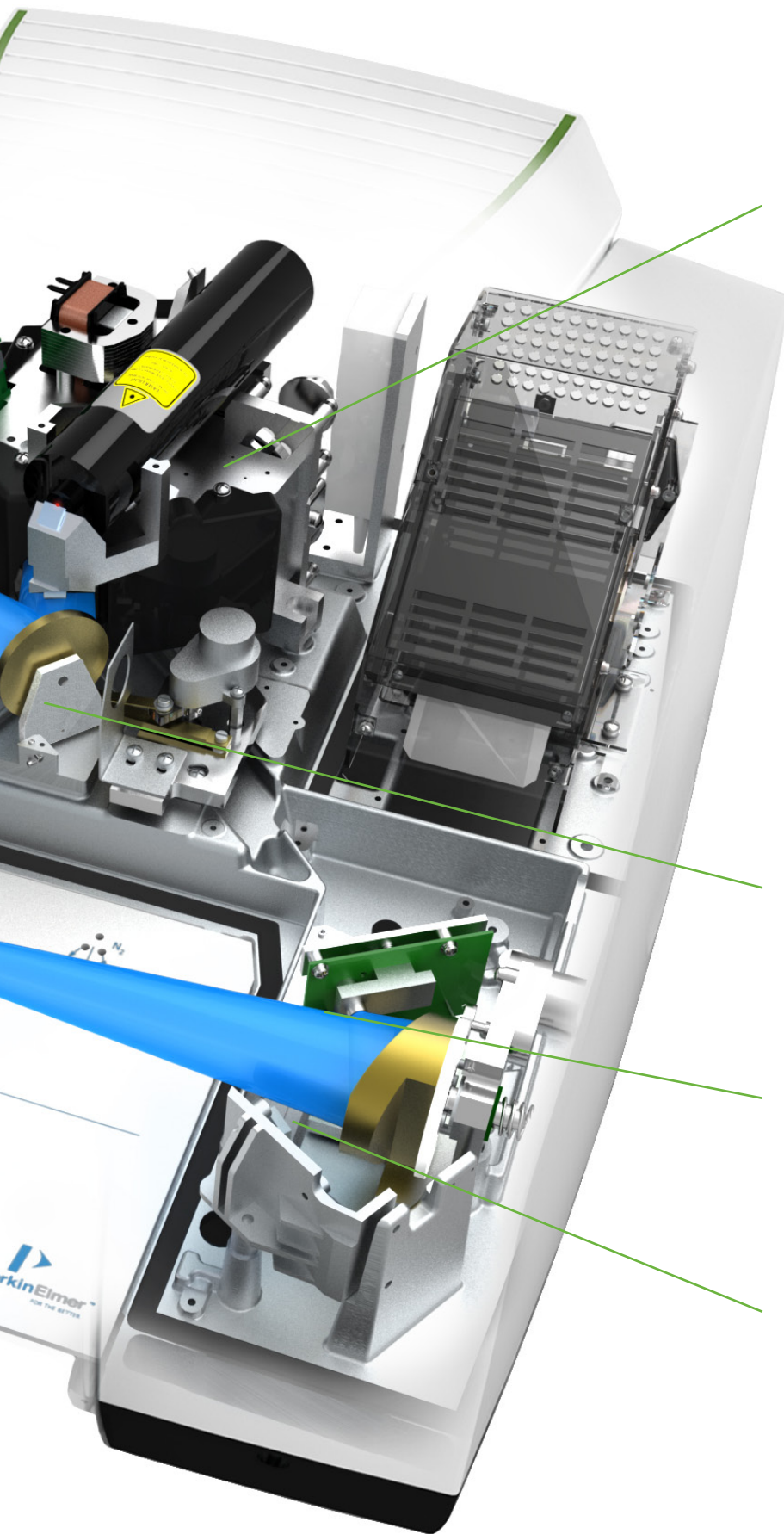

Patented Dynascan™ interferometer

Inherently stable design does not require dynamic alignment correction to compensate for errors found in linear mirror movement systems. Field-proven interferometer mechanism incorporates a simple, non-critical bearing for unmatched longevity and reliability

Sigma-Delta conversion

Our use of Sigma-Delta converters in the digitization of the FT-IR interferogram improves dynamic range, reduces spectral artifacts and increases ordinate linearity to produce accurate, reproducible results.

Output focusing optics for second sampling station

Enables two sampling accessories to be installed simultaneously, removing the need to switch modules between measurements

Temperature-stabilized DTGS detectors

All DTGS detectors are electronically controlled to ensure excellent reproducibility, regardless of ambient laboratory temperature

Second-detector configuration

Sensitivity can be increased by adding a second detector, such as a cooled MCT detector (not shown)

SPECTRUM SOFTWARE SUITE

Spectrum 10™ full-featured instrument control and data management software allows you to easily acquire and process data. From sample identification and quantitative analysis to advanced applications, the Spectrum comprehensive software suite allows you to focus on what matters most – results. Standard features in the basic software package, such as the powerful process chain functionality, allow complex data processing to be simplified to a single mouse click. The combination of intelligent software and advanced engineering ensures PerkinElmer Frontier systems deliver performance and ease of use to address your most demanding IR requirements with maximum efficiency.

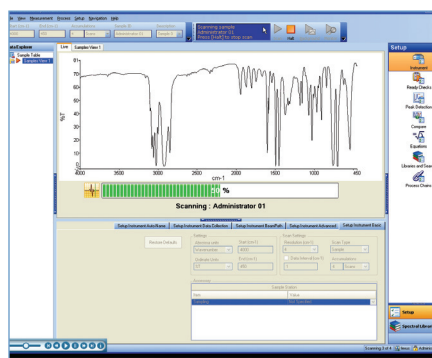

Frontier's Spectrum 10 software has a powerful, intuitive interface with live spectral and results update display, allowing users to easily acquire data. This also allows real time monitoring of spectra during the optimization of accessories. The process chain functionality allows complex data processing to be simplified to a single mouse click.

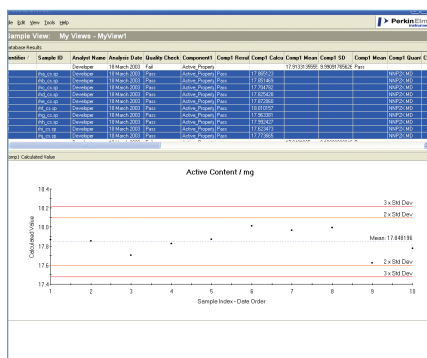

AssureID™ is the industry-leading workflow acquisition and analysis interface with results charting and full 21 CFR Part 11 compliance option providing the most powerful solution for product screening and qualification.

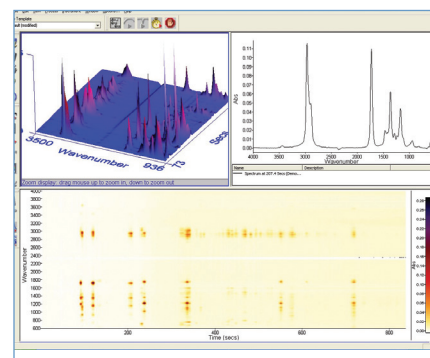

Research applications are supported by Spectrum Timebase™ and Spectrum Image™ packages. This powerful data acquisition and processing suite covers time and spatially resolved techniques.

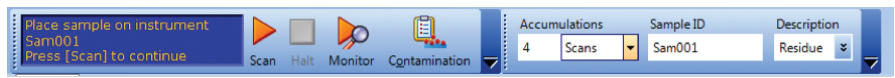

Take control of your FT-IR

Frontier's software offers instant access to both instrument commands and parameters through its unique instrument toolbar. The on-screen toolbar can be configured to include just a scan button, instrument status indicator and entry field for scan time, ensuring instrument operation is more efficient and reproducible.

For advanced settings the setup pane can be raised to reveal full parameter setups. The intelligent layered screen arrangement also enables advanced settings to be viewed while data is collected and processed.

Automatically configure accessories

Plug and play allows smart sampling accessory recognition when an accessory is changed or added to the Frontier systems. Spectrum 10 automatically reconfigures the FT-IR to quickly accommodate the new accessory.

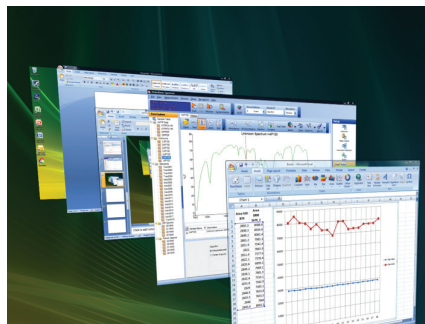

Seamlessly transfer multiple results to other Microsoft™ applications

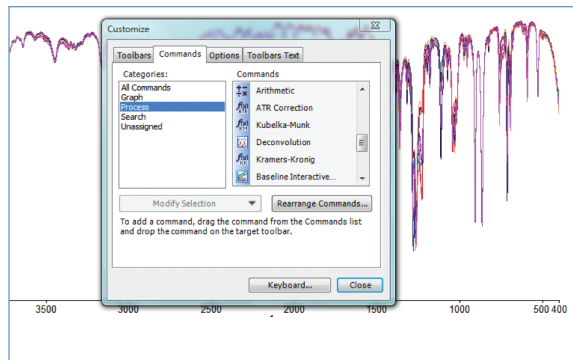

Customise your workbench

Spectrum 10 is fully customizable in both operator functions and software appearance, meaning the commands you need are at your fingertips. Enhanced configurability of the spectrum graph area allows set-up of all aspects of the drawing area, enabling you to get your presentations and reporting just right.

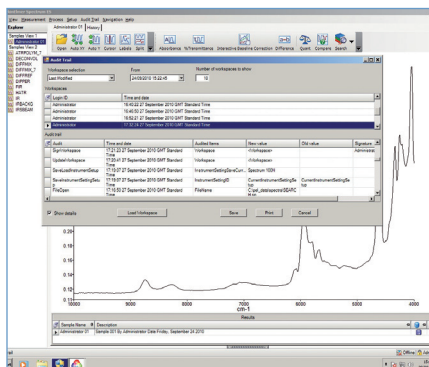

21 CFR Part 11 compliance

Spectrum's Enhanced Security (ES) software complies with 21 CFR Part 11, a mandatory requirement for pharmaceutical companies. To ensure full compliance, our software limits system access to only authorized users and provides a robust and comprehensive audit trail.

SPOTLIGHT



YOUR SAMPLE IN THE SPOTLIGHT

The same interferometer platform used in every Frontier instrument also powers Spotlight™ imaging and microscopy technologies.

IR microscopy and IR/NIR imaging systems

The flexibility of PerkinElmer optics allows you to upgrade your spectrometer, at any time, to include PerkinElmer's industry-leading microscopic and imaging functionality, including Spotlight 150, 200 and 400 systems. Spotlight is a range of high performance FT-IR microscopy and FT-IR/NIR imaging systems that use the same patented interferometer technology as in the PerkinElmer Frontier platform.

Spotlight imaging systems reveal the identity of a vast array of chemical components within materials, as well as displaying areas of homogeneity and variation. A preferred materials-testing technique due to its speed, ease-of-use and reliability, FT-IR/NIR imaging provides higher level understanding to facilitate your research.

Frontier microscopy options include both transmission and reflection micro-sampling, and its Micro ATR option provides information down to areas as small as 3 μ . A number of sample automation and detector options are available to suit many applications.

Spotlight data from a tomato seed

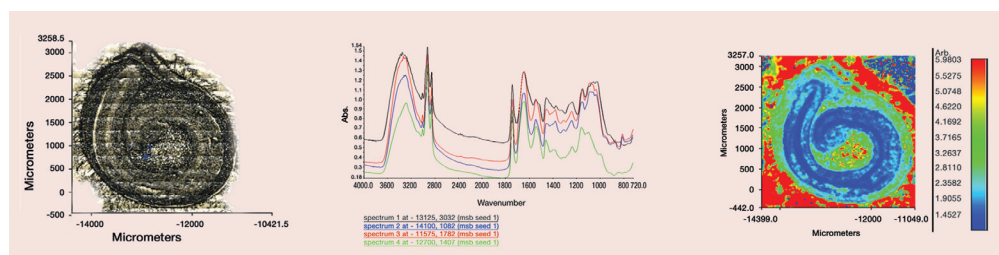

SPOTLIGHT APPLICATIONS

The Spotlight 400 imaging systems meet the challenges of many applications

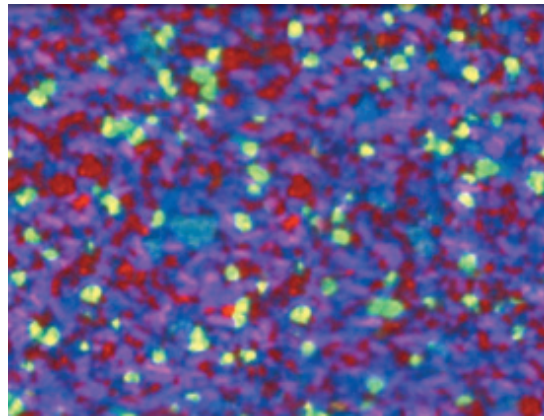

Pharmaceuticals

Distribution of ingredients in an over-the-counter pharmaceutical tablet showing particles $<5 \mu$ in size with ATR imaging

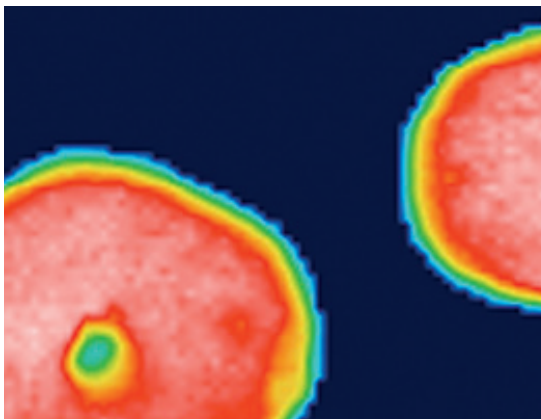

Academia and research

ATR image of a hair follicle demonstrating ca. 5μ spatial resolution

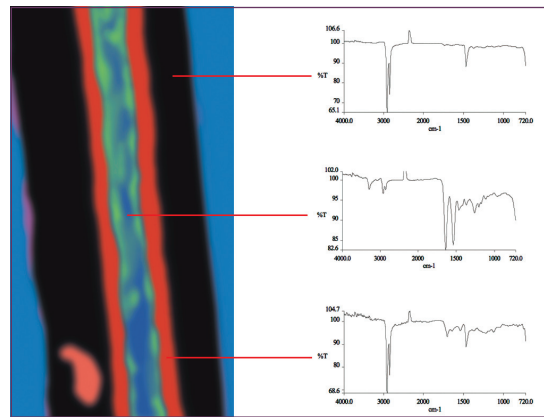

Chemicals and materials

ATR image of a polymer laminate showing individual layers of $<10 \mu$ thickness

FRONTIER OPTICA FT-IR

Specifically designed for highest ordinate accuracy in the IR region, Frontier Optica is a unique FT-IR spectrometer designed for the optical filter, glass and semiconductor measurements which require improved levels of ordinate accuracy and reproducibility. Over the $5000-400 \text{ cm}^{-1}$ range, the Frontier Optica offers radically improved passband accuracy and stopband transmission accuracy to 6000 cm^{-1} .

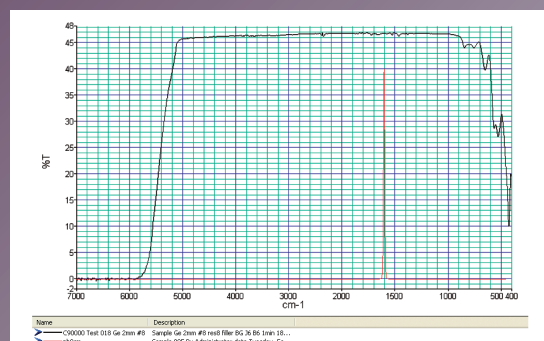

Accurate measurements of bandpass filters using Frontier Optica

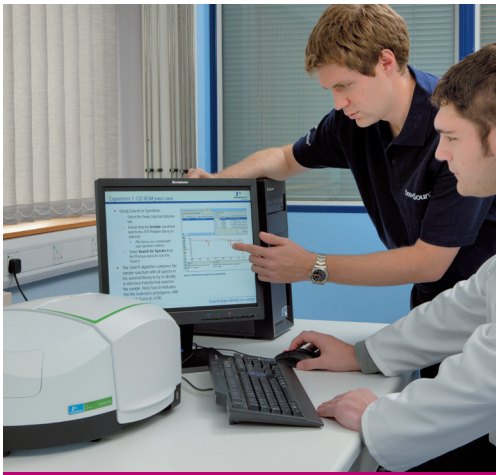

A RANGE OF SUPPORT SERVICES

Just as the PerkinElmer Frontier can be expanded and upgraded to meet your future needs, PerkinElmer offers a range of support services to guide you along the way. Our global network of over 1500 certified service technicians provide in-depth training, perform software and hardware upgrades and can protect your compliance status with our leading validation and qualification solutions.

Our high-quality engineering and extensive testing process ensures years of trouble-free service. While offering preventative maintenance and instrument care, our service engineers also provide on-site, on-demand repair as required. And with telephone support from personnel operating in 125 countries, help is just a phone call away.

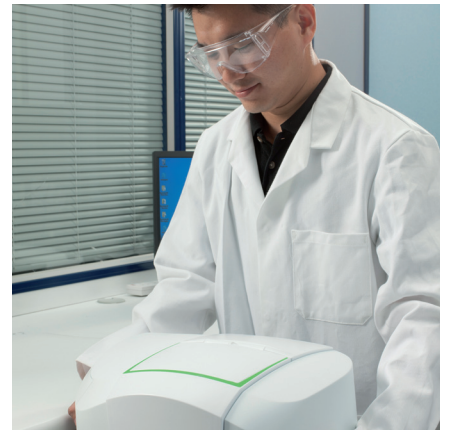



OUR LONG HISTORY OF WINNING IR TECHNOLOGY

Advancing spectroscopic analysis for over 65 years

- 1944 First IR spectrometer, the Model 12
- 1954 First commercial IR microscope
- 1957 First low-cost IR instruments
- 1975 First micro-processor controlled instrument, the Model 281
- 1984 First rotating mirror pair design FT-IR
- 1987 First low-cost FT-IR
- 1990 First all-Cassegrain-objectives FT-IR microscope
- 1991 First FT-IR company to gain ISO 9001 accreditation
- 1995 First validated FT-IR software, Spectrum for Windows®
- 1998 First FT-IR with smart accessory recognition
- 2001 First rapid-scanning chemical imaging system
- 2003 First FT-IR platform for both micro- and macro-scale analysis of pharmaceutical materials
- 2004 First on-site fully upgradeable microscopy system
- 2005 First integration of software sample table and remote sampling interfaces
- 2007 First FT-IR/FT-NIR spectrometer with automated range switching
- 2008 First high-accuracy FT-IR developed for optical filter measurements
- 2011 First laboratory performance, low maintenance and portable FT-IR for everyday analysis

BETTER SOLUTIONS FOR DEMANDING APPLICATIONS

The right consumables, methods and application support are as integral to the success of your laboratory as your instrumentation. That's why we invest heavily in testing and validating our complete portfolio of solutions to ensure that you receive accurate, repeatable results, on-time, every time throughout the lifetime of your instrument.

Whether you are conducting routine raw materials validation or performing the most demanding applications analysis, your success is our top priority. Together, we can help improve your efficiency, control costs, and optimize your analysis.

Are you ready for any challenge?

Systems and accessories: complete range of near-, mid-, far-IR spectrometers and sampling accessories

Consumables and supplies: broad portfolio that runs the full spectrum of applications

Training: on-line, on-site or classroom courses offered globally

Service: preventative maintenance, instrument care, or on-demand repair packages available



For more information, visit www.perkinelmer.com/frontier

PerkinElmer, Inc.
940 Winter Street
Waltham, MA 02451 USA
P: (800) 762-4000 or
(+1) 203-925-4602
www.perkinelmer.com



For a complete listing of our global offices, visit www.perkinelmer.com/contactus

Copyright ©2011, PerkinElmer, Inc. All rights reserved. PerkinElmer® is a registered trademark of PerkinElmer, Inc. All other trademarks are the property of their respective owners.

009431_01

Printed in the UK