

Instruction manual

VWR® INCU-Line, DRY-Line, VENTI-Line Prime Incubators and Ovens

European Catalogue Numbers:

INCU-Line

IL 56 Prime: 390-1346

IL 112 Prime: 390-1349

IL 180 Prime: 390-1350

DRY-Line

DL 56 Prime: 466-0600

DL 112 Prime: 466-0601

DL 180 Prime: 466-0602

VENTI-Line

VL 56 Prime: 466-0603

VL 112 Prime: 466-0604

VL 180 Prime: 466-0605



CE

UK
CA

Legal address of Manufacturer

Europe

VWR International bv
Researchpark Haasrode 2020
Geldenaaksebaan 464 B-3001 Leuven
+3216385011
be.vwr.com

UK Importer

VWR International Ltd
Hunter Boulevard, Magna Park
Lutterworth, Leicestershire, LE17 4XN
uk.vwr.com

Country of Origin

POLAND

Equipment disposal



This equipment is marked with the crossed out wheeled bin symbol to indicate that this equipment must not be disposed of with unsorted waste.









Instead it's your responsibility to correctly dispose of your equipment at lifecycle -end by handing it over to an authorized facility for separate collection and recycling. It's also your responsibility to decontaminate the equipment in case of biological, chemical and/or radiological contamination, so as to protect from health hazards the persons involved in the disposal and recycling of the equipment.





For more information about where you can drop off your waste of equipment, please contact your local dealer from whom you originally purchased this equipment.

By doing so, you will help to conserve natural and environmental resources and you will ensure that your equipment is recycled in a manner that protects human health.

Thank you!

Contents

1. INTENDED USE AND IMPORTANT INFORMATION FOR THE USER	5
2. PACKAGE CONTENTS	7
3. BEFORE THE FIRST USE	8
3.1. Installation of shelves.....	9
3.2. Wear and tear parts	9
3.3. Remarks on the placement of samples	9
3.4. Closing the chamber	10
4. OVERVIEW	11
5. UNIT OPERATION	12
5.1. Internal memory.....	12
5.2. First boot.....	12
5.3.  Main Screen.....	13
5.3.1. Alarm bar	13
5.3.2. Information panel.....	13
5.3.3.  Alarms panel.....	15
5.3.4.  Status panel.....	16
5.4.  Programs	17
5.4.1. Program making / edition.....	17
5.4.2. Segments edition.....	18
5.4.3. Summary of segments	20
5.4.4. Loop.....	21
5.4.5. Priority.....	21
5.4.6. Protection class.....	22
5.5. Starting the program	22
5.6. Quick change of parameters.....	25
5.6.1. Quick change the set temperature.....	25
5.6.2. Quick change the set time	25
5.6.3. Quick change of other parameters	26
5.7.  Statistics	27
5.8.  Data record	28
5.9.  Event log.....	29
5.10.  Info.....	30

5.11.		Interface.....	31
5.12.		Time.....	31
5.13.		Alarms.....	33
5.14.		Network.....	34
5.15.		Corrections	35
6.	COMPONENTS OF THE UNIT		36
6.1.	Internal glass door (only for INCU-Line).....		36
6.2.	Door lock		36
6.3.	Access port.....		36
6.4.	Open door alarm.....		37
6.5.	USB port.....		37
7.	TEMPERATURE PROTECTION		38
8.	REMOTE CONTROL OF THE UNIT		38
9.	CLEANING AND MAINTENANCE OF THE UNIT		39
9.1.	Exterior cleaning		39
9.2.	Interior cleaning		40
10.	ADVICE ON HOW TO SAFELY STORE THE UNIT		40
11.	TROUBLESHOOTING		41
11.1.	Possible defects.....		41
12.	WARRANTY CONDITIONS		42
13.	PRODUCT IDENTIFICATION LABEL		43
14.	TECHNICAL DETAILS		44

1. INTENDED USE AND IMPORTANT INFORMATION FOR THE USER

The DRY-Line and VENTI-Line drying ovens are designed for all standard drying and tempering tasks as well as sterilizing glassware.

They are intended for use in biological, chemical, medical, pharmaceutical and physical laboratories.

Any other use is not intended, and can cause damage and be harmful to health.

The DRY-Line and VENTI-Line drying ovens should not, in particular, be used to prepare foods intended for consumption or to sterilize or decontaminate medical products or medical equipment as defined by the Medical Device Directive 93/42/EEG (MDD).

The INCU-Line microbiological incubators are designed to cultivate microorganisms at defined temperatures. It can be used e. g. for determining the number of microorganisms through plate count methods or detecting of pathogenic germs in clinical samples or product samples.

It is intended for use in laboratories in these sectors: life sciences, clinical medicine, veterinary medicine, the pharmaceutical industry, the food industry, toxicology, and fundamental research into biology and pre-clinical medicine.

Any other use is not intended, and can cause damage and be harmful to health.

The INCU-Line incubator should not, in particular, be used to prepare foods intended for consumption or to sterilize or decontaminate medical products or medical equipment as defined by the Medical Device Directive 93/42/EEG (MDD).

To guarantee your security and the longest efficiency of the unit, please comply with the following rules:

1.	<u>The unit cannot be installed:</u> <ul style="list-style-type: none">• outside,• in damp places or places which can be easily flooded,• near flammable or volatile substances,• near acids or in corrosive environments.
2.	<u>It is forbidden to:</u> <ul style="list-style-type: none">• store inflammable or volatile substances inside the unit,• touch live parts of the unit• operate the unit with wet hands,• put water vessels on the unit,• climb or put any objects on the unit,• overload the shelves (the maximum load is described in technical data)

3. You should:

- place samples in such a way to provide proper air circulation in the chamber
- open the door for the shortest period of time to reduce temperature fluctuations
- secure samples from being blown out by the chamber fan e.g powdery samples
- always check that the doors are closed
- use only mains with earth to avoid electric shocks,
- unplug the power cable holding the protective cover and not the cable itself,
- disconnect the unit from the mains before undertaking any repairs or maintenance works,
- protect the power cable and the plug from any damage
- disconnect the power plug before moving the unit,
- disconnect the power plug if the device will not be used for a long period of time,
- disconnect the unit and protect it from reconnecting if it has any visual faults.

2. PACKAGE CONTENTS

INCU-Line devices are delivered with the following equipment:

56 & 112 Prime: 2 stainless steel wire shelves with set of slides – 2 pcs. each, keys to the lock (2 pcs.), manufacturer test certificate at 37°C. Multilingual instruction manual can be downloaded from internal memory on USB Stick.

180 Prime: 3 stainless steel wire shelves with set of slides – 2 pcs. each, keys to the lock (2pcs.), manufacturer test certificate at 37°C. Multilingual instruction manual can be downloaded from internal memory on USB Stick.

DRY-Line and VENTI-Line devices are delivered with the following equipment:

56 & 112 Prime: 2 stainless steel wire shelves with set of slides – 2 pcs. each, keys to the lock (2pcs.), manufacturer test certificate at 105°C. Multilingual instruction manual can be downloaded from internal memory on USB Stick.

180 Prime: 3 stainless steel wire shelves with set of slides – 2 pcs. each, keys to the lock (2pcs.), manufacturer test certificate at 105°C. Multilingual instruction manual can be downloaded from internal memory on USB Stick.

Additional shelves, a base on castors for all 180 liters Prime models and Premium Control software can be ordered separately:

Description	Quantity	Cat. No.
Additional stainless steel shelf for 56 liter models	1	466-0454
Additional stainless steel shelf for 112 liter models	1	466-0455
Additional stainless steel shelf for 180 liter models	1	466-0456
Base on castors for 180 liter models, height 470 mm	1	466-0457
Premium Control software	1	390-1323

3. BEFORE THE FIRST USE

On the surface of unit components made of stainless steel, slight discoloration may occur. It is a result of the technologies used in the production of metal sheet in accordance with the requirements of PN-EN 10088-2 standard and it is not a defect of the unit.



Upon delivery please check the package visually at the courier's presence. The delivering company bears responsibility for any damage during transport.

The place of installation of the unit should meet the following conditions:

- Ambient temperature +10°C...+28°C,
- The unit has not been designed to work in highly dusty environments
- The place of installation should be appropriately ventilated according to its size
- The unit should be put on a hard and stable substrate
- The unit should be placed at least 100 mm away from the wall
- The height of the room must be at least 300 mm greater than the height of the unit
- The unit is not designed to be built-in
- The place of installation of the unit should contain a mains socket.

If you don't comply with the above recommendations, the unit may get broken or it may worsen the technical parameters.

The unit has been equipped with leveling feet. Please use them to level the unit after it has been placed in its final location.



While operating the unit:

- the door must be closed
- the access port must be closed with security cap

The electric installation should meet the following conditions:



The device is powered by AC 230V/50Hz. Please connect it to a socket with ground in order to avoid electric shocks in case of the unit's failure.

3.1. Installation of shelves

Perform the following steps to adjust shelf height:



- 1) Install the shelf holder at the selected height by inserting it into proper slots on wall.
- 2) Install the second shelf holder on the opposite wall.
- 3) Slide the shelf into the shelf holders.
- 4) Done!

To remove a shelf, perform the above steps in reverse order. To remove the shelf holder from the slots, lift it up and slide it towards the rear of the chamber.

3.2. Wear and tear parts

There are the following wear and tear parts - door gasket.

3.3. Remarks on the placement of samples

To provide proper air circulation and stable conditions in which the samples are stored in the chamber, it is necessary to keep the following rules:

- the max height of the samples should not exceed 1/3 of the space below the shelves
- the samples should be placed in such a way that so that the horizontal surface between the containers does not exceed 1/3 of the width and height of the empty shelf

- the space between the samples and between the samples and the wall should be more or less equal

The picture below is an example of the placement of samples in the chamber.

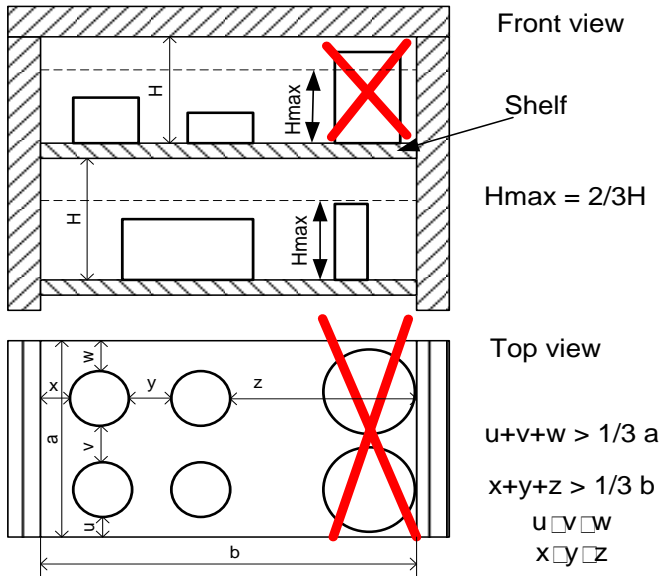

Following the above rules will provide best optimal parameters of temperature variation and fluctuation.

3.4. Closing the chamber

The door has been equipped with a door handle. To close the door, turn the handle to the vertical position, push the door gently and turn the handle to the horizontal position. Closing the door correctly reduces energy consumption and ensures proper temperature stability and uniformity.

4. OVERVIEW

- 1) USB socket
- 2) Electronic controller with 4.3" touch panel
- 3) Entry port (Ø 30mm) on left side
- 4) Temperature sensors
- 5) Chamber fan (only VL)
- 6) Shelf
- 7) Internal glass door (only IL)
- 8) Height adjustable feet
- 9) LAN
- 10) Socket (for power cable)
- 11) Main power switch
- 12) Fuse
- 13) Fan for controller
- 14) Air-flap

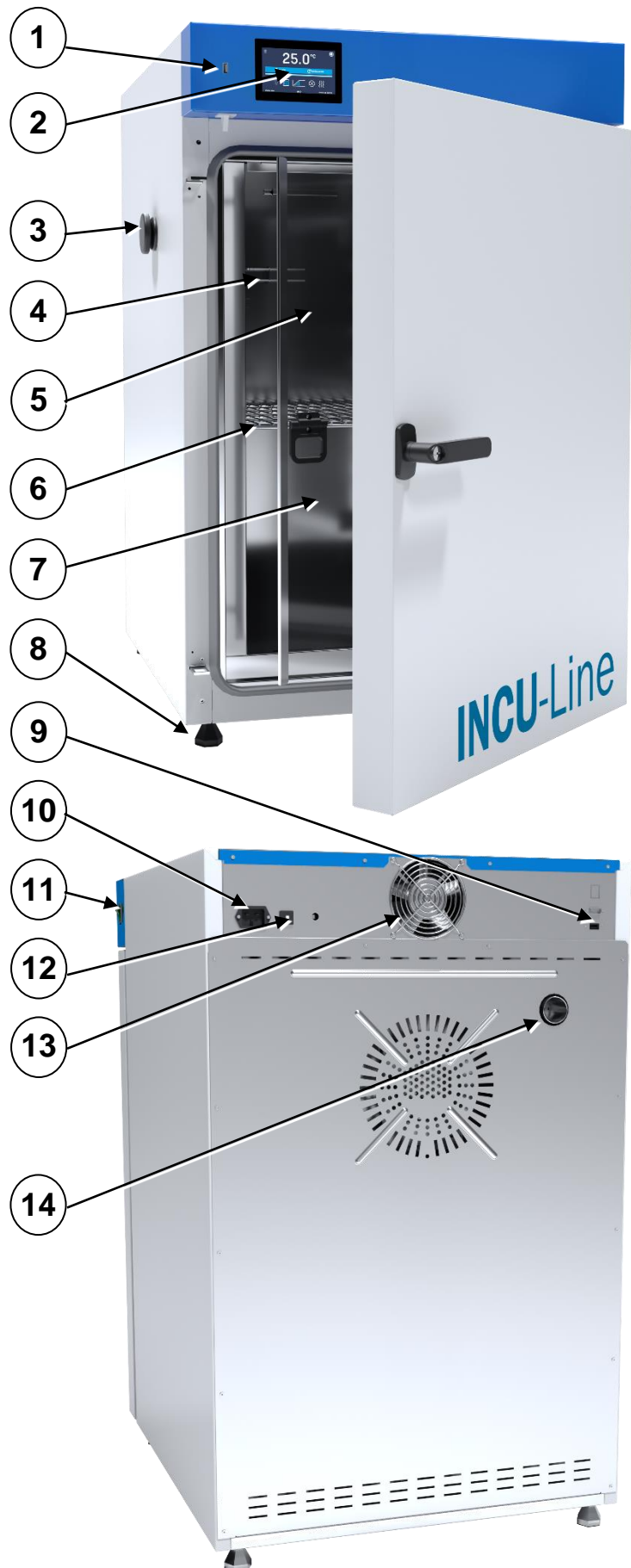

5. UNIT OPERATION



DRY-Line Prime and VENTI-Line Prime

Before the first using, it is recommended to heat the chamber (3 hours at 250°C). turn on the unit and set the temperature at 250°C. Then let the unit work for 3 hours. During the heating, the unit is likely to produce a specific smell.



This symbol means that a given field / window can be moved in the direction shown in the picture

5.1. Internal memory

During using the unit, it may be necessary to write or read the data from the external memory – a USB flashdrive. The USB flashdrive should be formatted the FAT 32 file system. The unit should be placed in USB slot located on the front the device, near to the display. Wait a few seconds, the corret reading is indicated by the message „USB flashdrive connected” at the bottom of the screen.



USB slot is used to connect a flash memory – a pendrive. Connecting other devices (external hard drives) or any other is not authorized by the manufacturer and may damage the USB slot.

5.2. First boot

During the first boot, the screen (*Figure 1*) will display proposing to save the "Download" folder (with instruction manual) on the USB flashdrive. Insert the USB flashdrive and wait a second to detect the hardware, then press . By pressing you quit downloading the folder, the window will appear again during the next start. You can tick „Don't show again” so that the window will not be displayed when you start. You can always download the "Download" folder in the information panel. More information, » [page 30](#)

Figure 1 - Manual

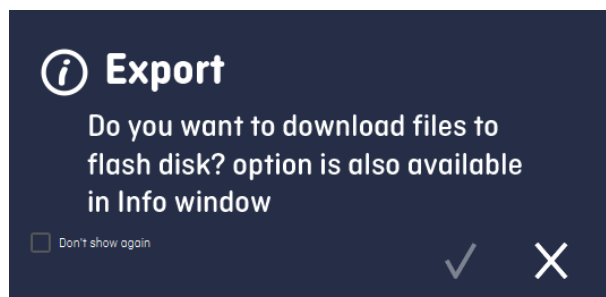

5.3. Main Screen

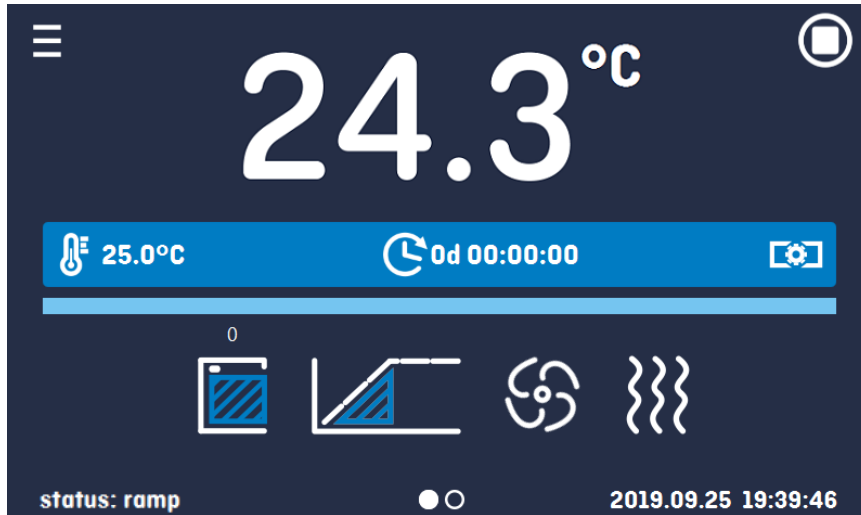

After switching on the device, the Main Screen (*Figure 2*) appears. It contains the information about the device status.

Figure 2 - Main Screen



5.3.1. Alarm bar

The colour of the bar indicates the status of the device:

	– blue – the device is working properly
	– red – alarm

5.3.2. Information panel

You can view two different windows. Switching between them is done by swiping your finger left or right

Information about which window is active indicates .

5.3.2.1. Status

Figure 3 - Status - icons



Closed door, open door. The number above the icon presents open door counter, press the icon to cancel the counter. The counter is also cancelled during turning on the device



Icon for the fan (only for VENTI-Line models). Rotating icon shows that the fan is running. Icon does not move at status program off or when the fan is defect*



Ramp status: Chamber is currently heating up to reach set temperature



Set temperature is reached



Icon is visible only when the chamber increases the temperature

5.3.2.2. Information

There are icons on information panel – one of them opens *Alarms panel* » [chapter 5.3.3](#). second *Status panel* » [chapter 5.3.4](#).

Figure 4



5.3.3. Alarms panel

In this place appears the list of alarms. With active alarm, the control bar is red. The alarm event is displayed in the list, with the status alarm active.

When an alarm event stops, the alarm remains in the list as inactive.

- “**delete**” button – confirms and removes the alarm from the list (only inactive alarms can be deleted),
- “**confirm**” button – confirms the class 2.0 alarm,
- “**details**” button – displays a preview of all instances of selected alarm ([Figure 6](#)).

Figure 5 – Alarms panel

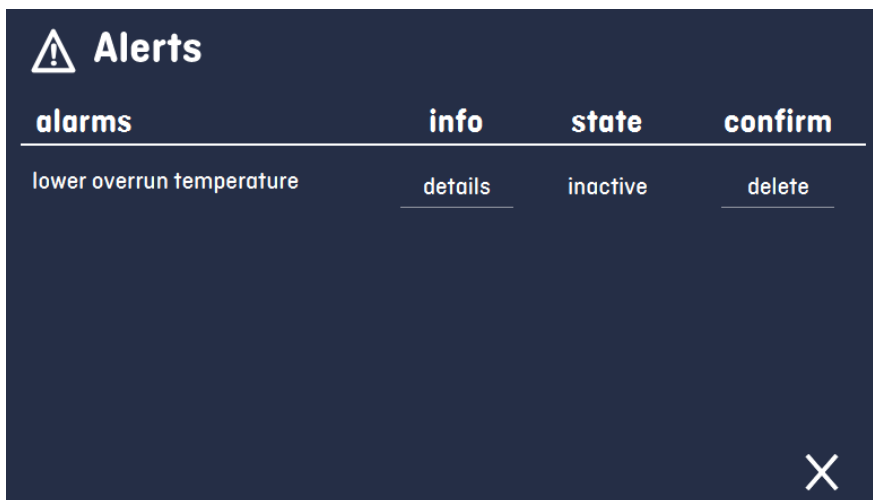
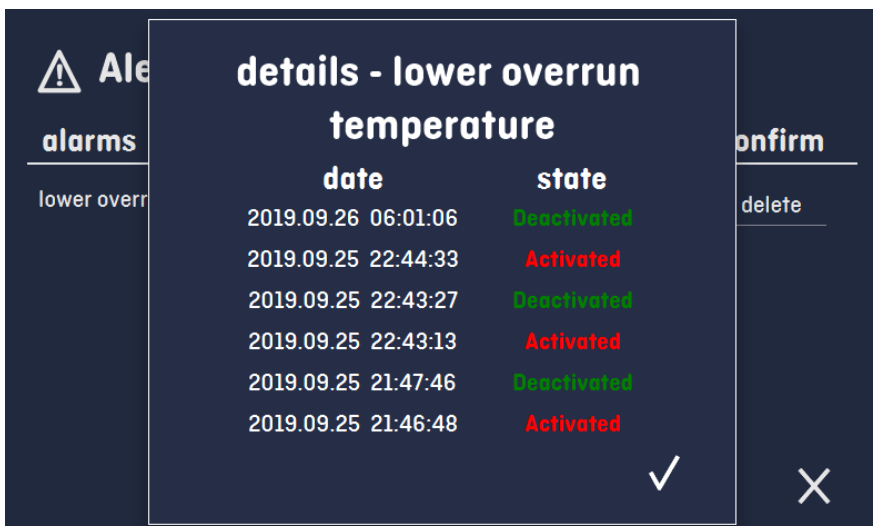

Figure 6 – Alarms details



5.3.4.  Status panel

The status of the device is indicated by description.

Figure 7 – Status - description

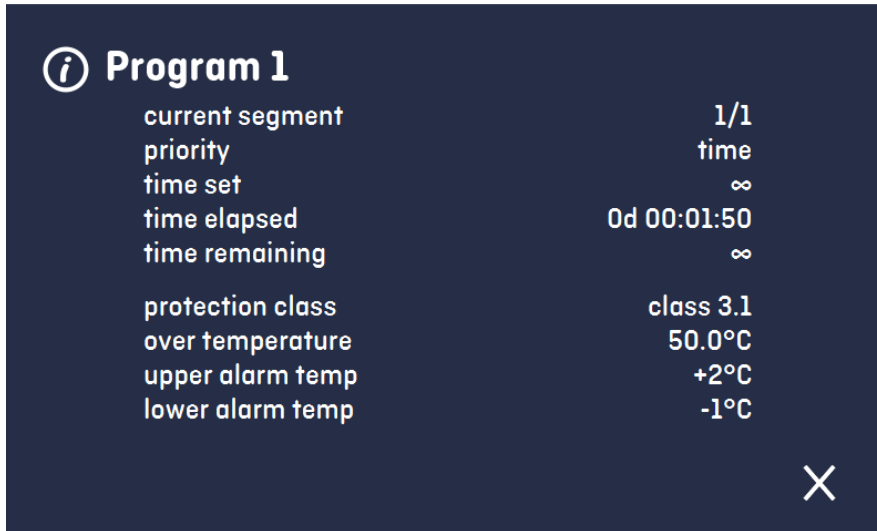

program name	The name of program
current segment	Currently performing segment / total number of segments in the program
priority	In regard of time or parameters, more information can be found on » page 21
time set	Set time of performing segment
time elapsed	Elapsed time after reaching the segment
time remaining	Remaining time until the end of the segment
current loop	Currently performing cycle/ total number of cycles to perform » page 21
protection class over temperature	Information about the protection temperature associated with a running or completed program. The protection parameters can be set in the program parameters. Information about protection classes » page 22 .
upper alarm temp lower alarm temp	information about the set alarms, separately for overrunning up and down. Alarms set » page 33 .

5.4. Programs

In this panel (*Figure 8*) you can run the selected program, add a new one, edit the program or delete it.

Menu push buttons:



Run the selected program



Stop the program



Add a new program



Edit the selected program





Delete the selected program

Figure 8 – List of programs

name	segments	priority
Program 1	1	time
Program 2	1	parameters
Program 3	2	parameters

Information about the number of created programs and the programs to be created is presented at the top **A**.

5.4.1. Program making / edition

Press the button  or , and a panel with program parameters will appear (*Figure 9*).

The name of the program is completed automatically.

You can set the panel:

- **Segments number** – the number of segments (max. 5 segments)

- **Interval** – frequency of saving to data logging
- **Protection class** – more information » [page 22](#)
- **Protection temperature** – temperature range for the protection class
- **Priority** – the priority of time or parameters, more information » [page 21](#)
- **Loop** – the number of program repetitions, more information » [page 21](#).

Figure 9 - Program parameters



Cancel adding or editing of the program

Switching to the edition of program segments



With more parameters you can scroll the panel up and down.

5.4.2. Segments edition

Press the button , and the first program segment will appear ([Figure 10](#)).

In this window you can set:

- **temperature** – target temperature which the device is to achieve in this segment, (can't be higher than over temperature protection -2°C).

- **time** – the time of maintaining the set temperature ([d hh:mm]) (days, hours and minutes) it is possible to select continuous work in the last segment. ∞
- **ramp time** – the time of reaching the set temperature ([d hh:mm]) (days, hours, minutes)
- **fan** – fan efficiency in percent, adjustable in increments of 1% (only for VENTI-Line models),
- **flap** – the level of air-flap opening (0% - closed, 100% - open, adjustable in increments of 1%)
- **ramp fan** – fan efficiency during reaching the set temperature, adjustable in increments of 1% (only for VENTI-Line models)
- **ramp flap** – the level of air-flap opening during reaching the set temperature (0% - closed, 100% - open, adjustable in increments of 1%)

The active value is highlighted in blue.

The item highlighted in red means that the value is out of range and you should enter another one, e.g. the temperature is above / below the operating range of the device or the protection temperature.



It is strongly recommended that you leave the fan speed at 100% as set by default.



With more parameters you can scroll the panel up and down.

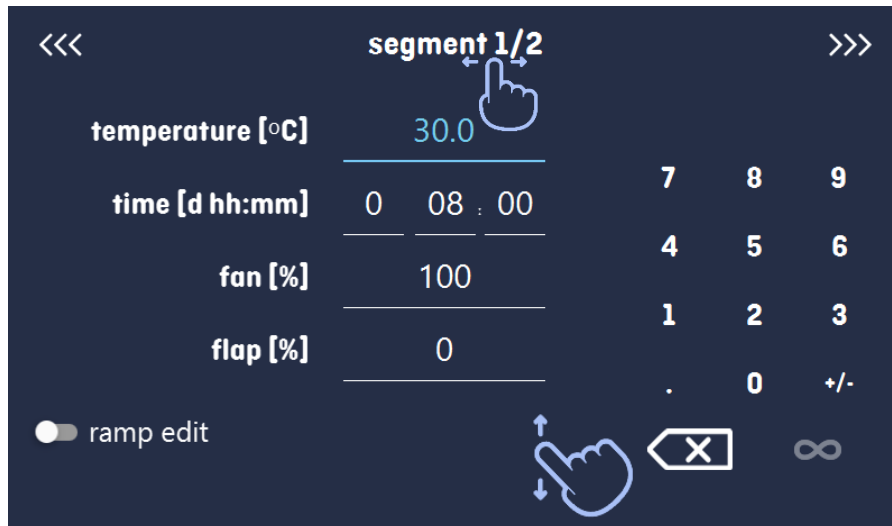

Figure 10 - Program segment edition

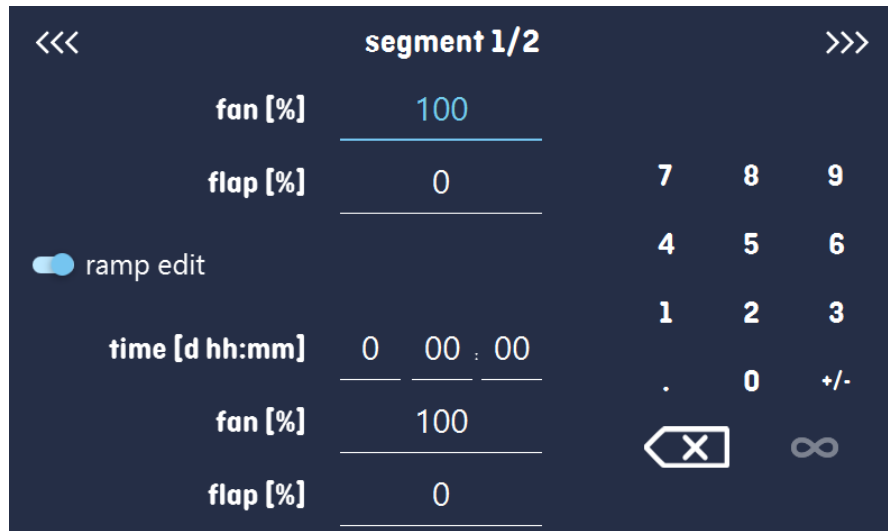

The ramp parameters are set to the values recommended by the manufacturer. If it is necessary to set individual parameters, activate the edit ramp field and set your own values.

Figure 11 - Program segment edition



The navigation between: segments, program parameters and summary is done by swiping up the segment with the finger or touch the icon  .

5.4.3. Summary of segments

In the summary in the figure all segments (Figure 12) are visible along with the entered settings:

- segment number,
- Temperature, duration time, target time of reaching temperature of a given segment
- Fan efficiency (only for VENTI-Line models)
- The percentage of air-flap opening.

Figure 12 – The summary of the program

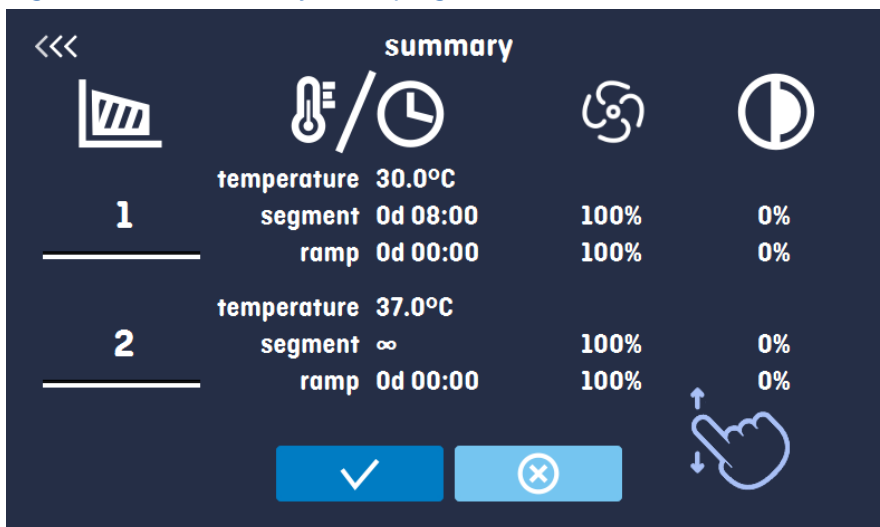



Confirms and saves the changes



Cancels the entered changes to segments and goes into program parameters.



With more parameters you can scroll the panel up and down.

5.4.4. Loop

The option is available if the number of segments is equal to 2 or more.

When the program finishes the last segment, the device starts the program again from the first segment.

You can define if a program should be carried out once (loop: 1) or multiple times (loop: 2 to 255). You can also set the program to be carried out continuously, tick the „∞“ option. If a cycle run is active, after finishing the last segment, the program will continue to carry out the first one.

5.4.5. Priority

Can be set in terms of:

Parameters:

The program without a ramp – the device starts the countdown of the segment time when the set temperature is reached.

The program with a ramp – first, the device counts down the time of the ramp and then proceeds to the segment countdown when the set temperature is reached. Regardless of whether the time of ramp elapsed.



It may happen that the device couldn't reach the set temperature within the set time because the reaching time was too short. In such situation the reaching time will be exceeded and the segment's time countdown will start when the set temperature is reached.

Time:

The program without a ramp – the device starts counting down the segment time when the program is started. Regardless of whether the temperature has been reached.

The program with a ramp – the device first counts down the ramp time and after its expiry it proceeds to the countdown of the segment time. Regardless of whether the temperature has been reached.



It may happen that the time of reaching was too short and the device failed to reach the set temperature within the set time. Then the countdown of the segment time will start before reaching the set temperature. Thus, the actual time of device stay in the set temperature will be shortened.

5.4.6. Protection class

Prime devices are equipped with cartridge protection – temperature protection, which is realized on the basis of the temperature value measured by an independent temperature sensor, the so-called security sensor.

The main aim of the cartridge protection is to protect against uncontrolled rise or fall in temperature. At the moment of activation, the relay disconnects the heating power supply.

The device is equipped with **Class 3.1** – over temperature protection – when the temperature drops below the set protection value, the power turns on automatically and after rising the temperature above the set protection value, the power turns off automatically.

The temperature set in the segment cannot be higher than the upper protection temperature less 2°C, e.g. the upper protection temperature: 50°C the maximum temperature set in the segment that can be given is 48°C.

More information see » [page 41](#).

5.5. Starting the program

You can start the program in two ways:

The first way



- Press the icon  „programs” in main menu ([Figure 13](#)).
- Then select the program you want to activate and press „Start” button  ([Figure 14](#)).

Figure 13 – Main menu

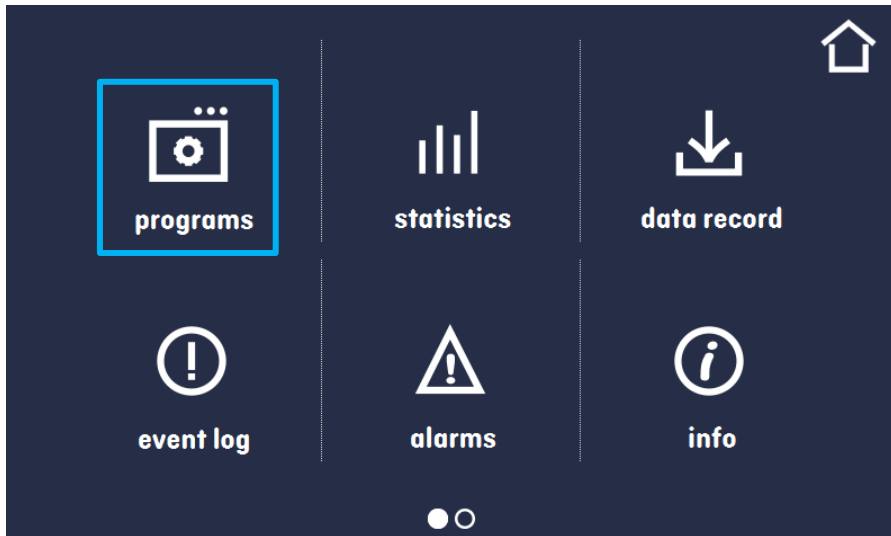
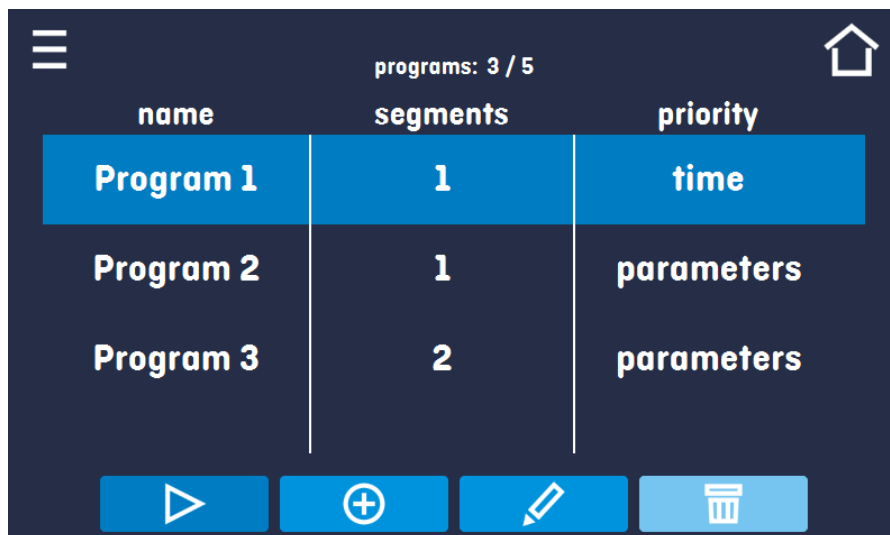

Figure 14 - List of programs



The second way

- In the main panel (Figure 15) press the icon in the upper right corner. 
- By pressing the icon you will go to the program selection window (Figure 16).
- Select the program you want to activate, you have got two additional options:

Figure 15 - Main screen

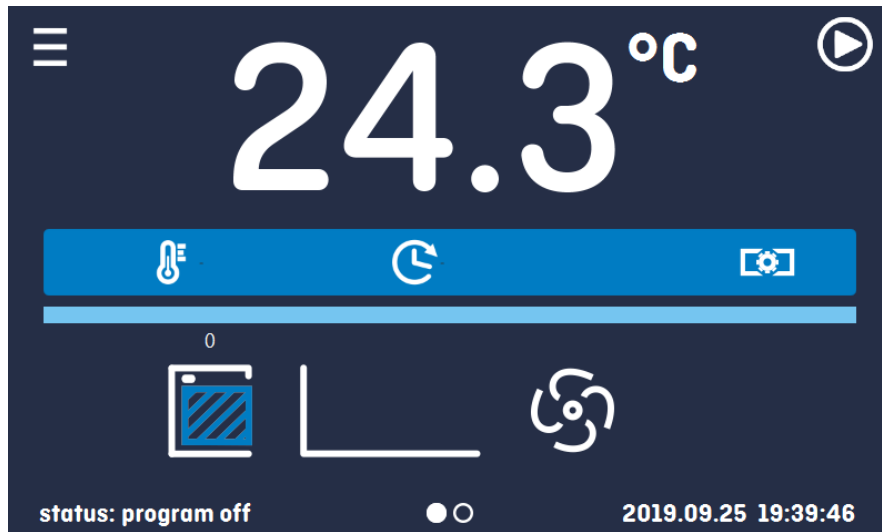

Figure 16 - Starting the program

PROGRAM		
name	segments	priority
Program 1	1	parameters
Program 2	2	parameters



Immediate start of the program



Scheduled program start according to the set date and time





It's possible to start a backdated scheduled program but only for programs with time priority and scheduled max. 7 days back. It is possible for time priority programs.

Program segments which last for a total period from the set date to the current date will be skipped.

5.6. Quick change of parameters

5.6.1. Quick change the set temperature

In order to quickly change the value of the set temperature of the program, press the icon  in main screen (Figure 2).

The value of the temperature should be selected by scrolling the list up or down (Figure 17). Confirm the change by pressing .

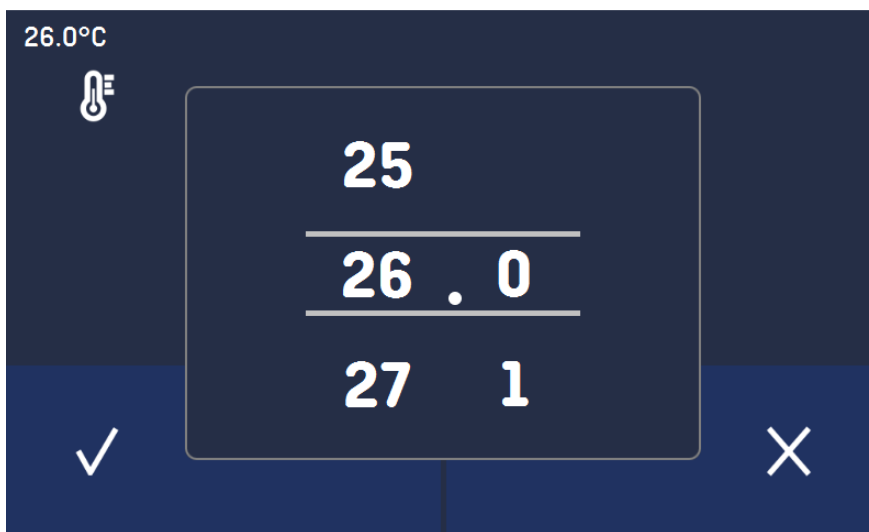

Temperature cannot be higher than protection temperature (over temperature) -2°C.

Figure 17 - Quick change of temperature



5.6.2. Quick change the set time

In order to quickly change the duration time of the program, press the icon  in main screen (Figure 2).

Select the number of days, hours and minutes by scrolling the list up or down (Figure 18). Confirm the change by pressing . To set the continuous work press .

To change the way of displaying the time, press:



- to display the elapsed time



- to display the remaining time

To change only the way of displaying, you do not have to confirm it by .

Figure 18 - Quick change of time



5.6.3. Quick change of other parameters

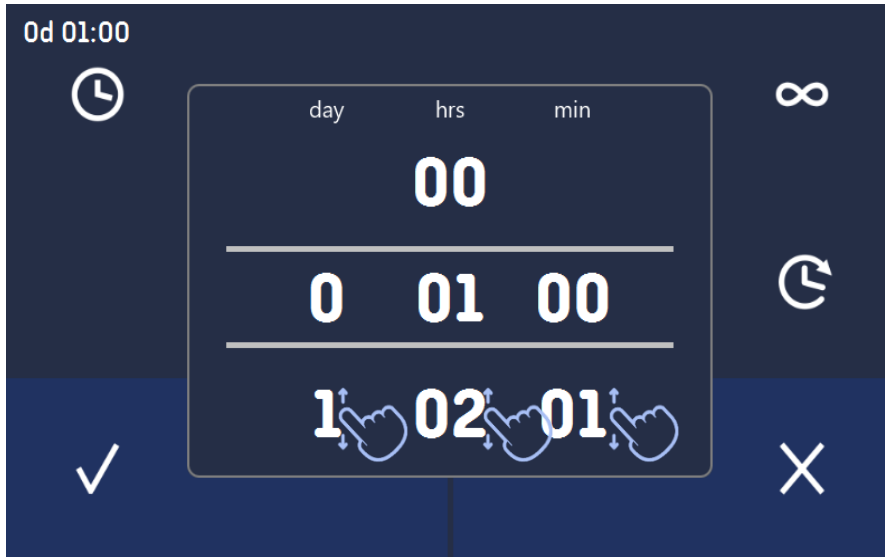

In order to quickly change of other parameters of the program, press the icon  in main screen (Figure 2). Select the parameter you want to change and make changes by strolling the list up or down (Figure 19). Confirm the change by pressing  .

Figure 19 - Quick change of other parameters



5.7. Statistics

This panel displays statistics about the currently running program or program that has ended. Statistics are calculated separately for each segment and for a current cycle. Data logging starts for calculation after 30 seconds from reaching the set temperature in the segment. The next data is registered every 1 minute.

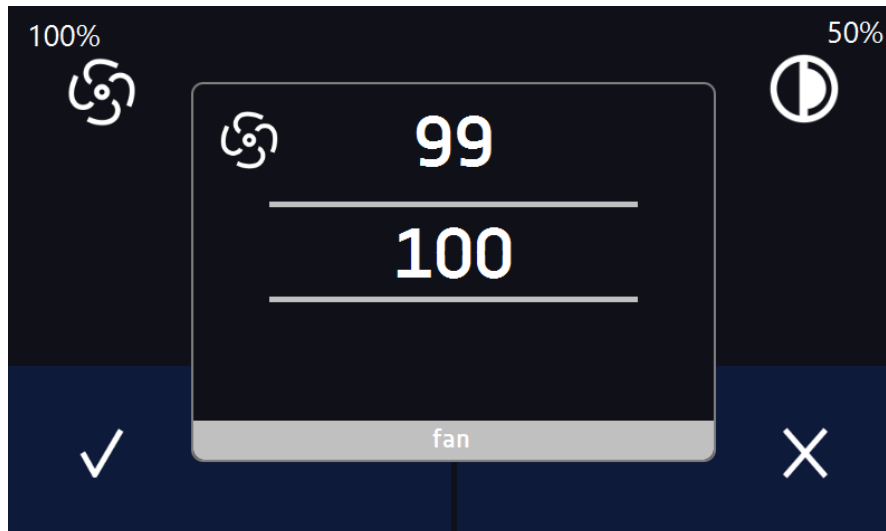
The following information is available:

- **Set temperature** [°C] – set temperature in the segment
- **Minimum temperature** [°C] – the lowest recorded temperature
- **Maximum temperature** [°C] – the highest recorded temperature
- **Average temperature** [°C] – average temperature
- **Segment** – status of the segment
 - In progress – currently performed segment (data is constantly updated)
 - finished – the segment is made,
 - interrupted – the segment was interrupted by the User before the set time expired
- **Segment 1/2** –the number of the currently overwiewing segment / number of the currently performed or completed segment. Navigating between the segments is done by swiping up your finger up or down.



You cannot overview the segment / cycle data that has not yet started.

Figure 20 - Statistic

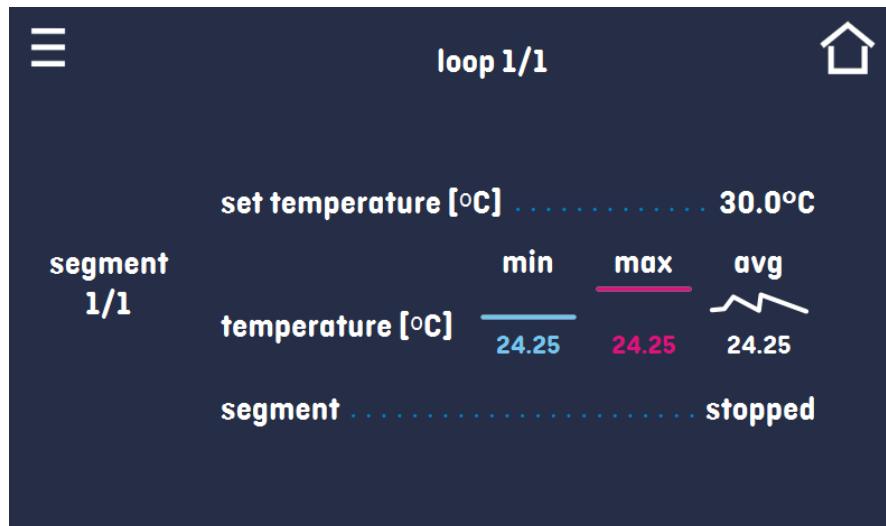

5.8.  Data record

Register window (*Figure 22*) contains the following information:

- Time of sample registration [date],
- Temperature value from the main sensor in the chamber [temp.].

It is possible to register 10 000 data records to use for the max period of 6 months. If all the memory cells are full, the oldest ones are overwritten. Data is displayed in the chronological order from the oldest to the latest record. It is possible to segregate data according to the selected column. To do so, click the column heading.

The samples are only registered when the program is running. The frequency of registration depends on the program parameters settings.



The time of opening the Data Register depends on the number of saved samples. The larger number of stored cells increases the opening time of the window. Then, a progress window will appear (*Figure 21*), indicating what date range has been displayed. By clicking on  you can stop loading and overview only some part of the data. By pressing the progress bar, you can minimize it (it will appear at the top of the screen) and overview the previously loaded data.

Figure 21 – Progress bar

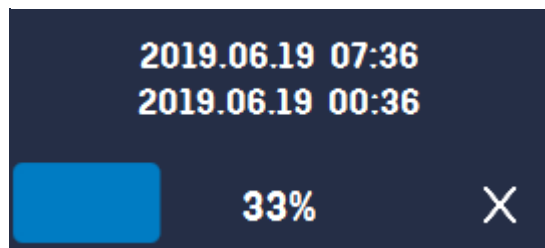



Figure 22 – Data Register

☰
🏠

date	temp.	status
2019.06.19 07:29	25.17	ramp
2019.06.19 07:26	25.17	ramp
2019.06.19 07:25	25.18	ramp
2019.06.19 07:24	25.18	ramp
2019.06.19 07:23	25.15	ramp
2019.06.19 07:03	25.15	ramp
2019.06.19 07:02	25.08	ramp
2019.06.19 07:01	25.06	ramp







Data recording onto the USB flash drive. .csv files are available - semicolon separated by opening eg with a spreadsheet, .plx - opening with the Premium Control application









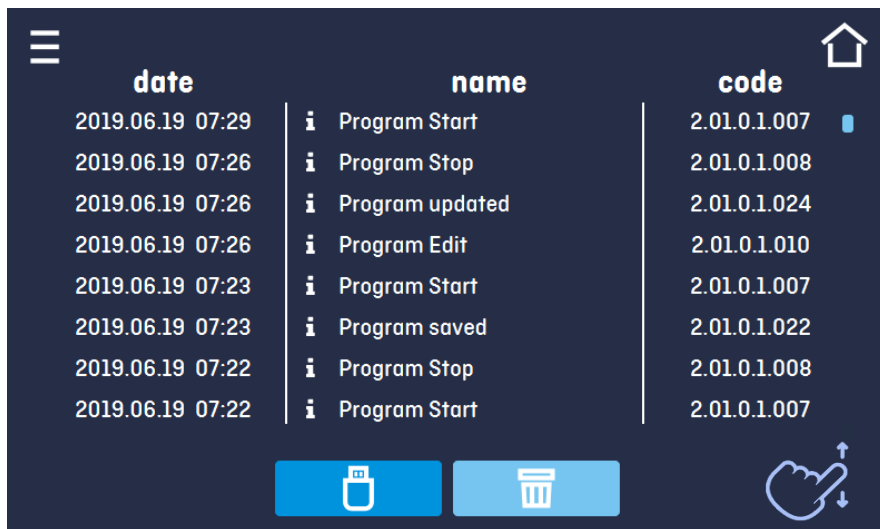

Deleting data.

5.9. **Event log**

The window displays information about registered events, alarms and errors.

Figure 23 – Events Register



date	name	code
2019.06.19 07:29	 Program Start	2.01.0.1.007
2019.06.19 07:26	 Program Stop	2.01.0.1.008
2019.06.19 07:26	 Program updated	2.01.0.1.024
2019.06.19 07:26	 Program Edit	2.01.0.1.010
2019.06.19 07:23	 Program Start	2.01.0.1.007
2019.06.19 07:23	 Program saved	2.01.0.1.022
2019.06.19 07:22	 Program Stop	2.01.0.1.008
2019.06.19 07:22	 Program Start	2.01.0.1.007



Saving the data onto USB flash drive. .csv files are available - semicolon separated by opening eg with a spreadsheet, .plx - opening with the Premium Control application



Deleting data



Information event



Alarm event



Error

Possible events:

Date/time change	data/time were changed
DeviceOn	the device is switched on (on the main switch)
DeviceOff	the device is switched off (on the main switch)
Door closed	the door is closed

Door opened	the door is opened
Open door alarm start	open door alarm has been activated
Open door alarm stop	open door alarm has been deactivated
Over Protection Start	over-temperature protection has been activated
Over Protection Stop	over-temperature protection has been finished
Program Edit	changing the program parameters
Program End	program is finished
Program Restarted	program has been restarted after power failure
Program Start	starting the program
Program Stop	stopping the program
Lower temp. alarm Start	lower temperature alarm has been activated
Lower temp. alarm End	lower temperature alarm has been finished
Upper temp. alarm Start	upper temperature alarm has been activated
Upper temp. alarm End	upper temperature alarm has been finished
Deleted All Measurement	all measurements have been deleted
Program saved	new program has been saved
Program deleted	program has been deleted
Program updated	program has been updated

5.10. Info

The panel contains the following information:

- Software versions,
- name of device,
- manufacturer's address,
- manufacturer's website.

Figure 24 – Info window



Press icon  to save the “Download” folder (among others with manual instruction) on the USB memory stick.

 - write the service data on the USB-stick – contact the service for more information.

5.11. **Interface**

In this panel ([Figure 25](#)) you can:





-  **English** Change the language of device
-  Set the time after which the screen will be dimmed
-  Turn on/off the sound, alarm sounds will be still emitted

Figure 25 – Interface settings

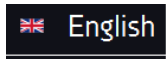

 Confirms and saves changes

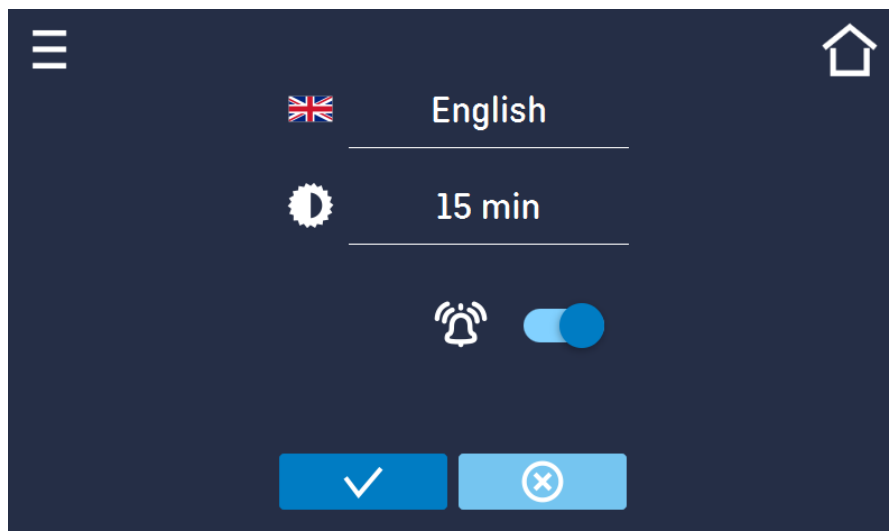
 Cancels the entered changes

5.12. **Time**

In this panel you can:

- change date / system time,
- change time zone

Date and time cannot be changed while the program is running.

If you change the date and time to an earlier than the current one, a message will appear on the display:

“Changing the date/time will interfere with the records in the database. Delete the data from data record and event log first, then change the date/time.”

You must first delete the data from the “data record” and from “event log” and then change the date/time.

To change the system date or time, press the button  (Figure 26). In the next window (Figure 27) you can change settings.

Figure 26 – Time

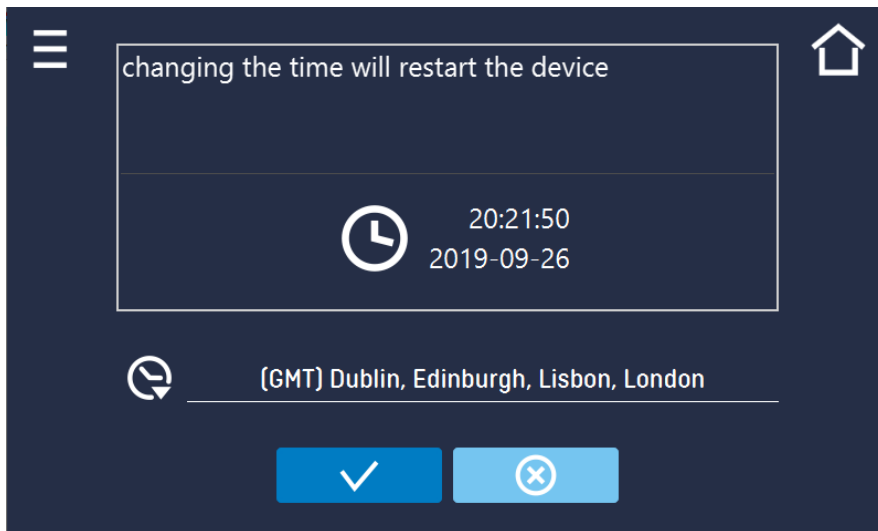
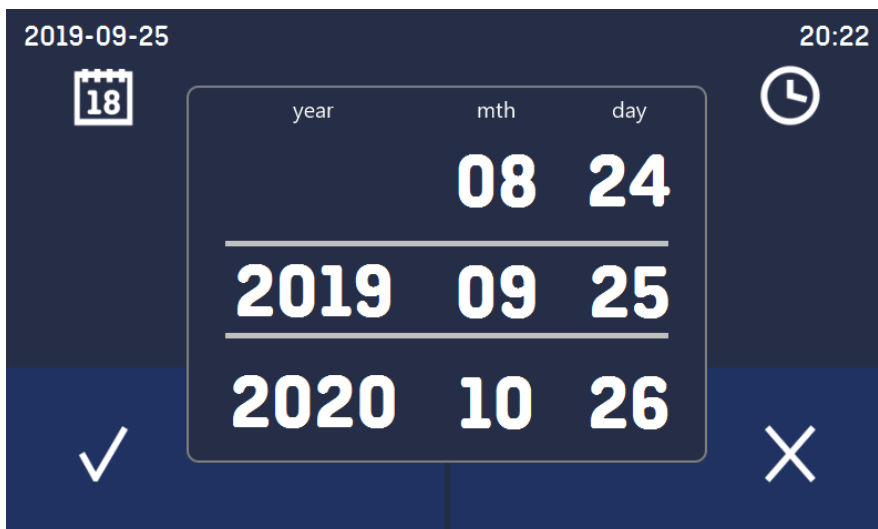

Figure 27 – Date settings



Confirms and saves changes



Cancel the entered changes



The same time zones are required for correct operation of programs on the device and computer.

5.13. Alarms

You can set parameters related to alarms.

- **lower alarm** – an alarm will be generated if the temperature drops below the value given in this field
- **upper alarm** – an alarm will be generated if the temperature rises above the value given in this field

The lower and upper alarm can only be generated after reaching the set temperature.

- **delay temp alarm:**
the alarm will be activated with a delay (1 min, 2 min, 5 min, 15 min) after exceeding the permitted temperature.
- **delay door alarm:**
the door alarm will be activated when the door is opened for the time selected by the user (5 s, 30 s, 1 min, 5 min, 10 min).

Figure 28 – Alarm settings

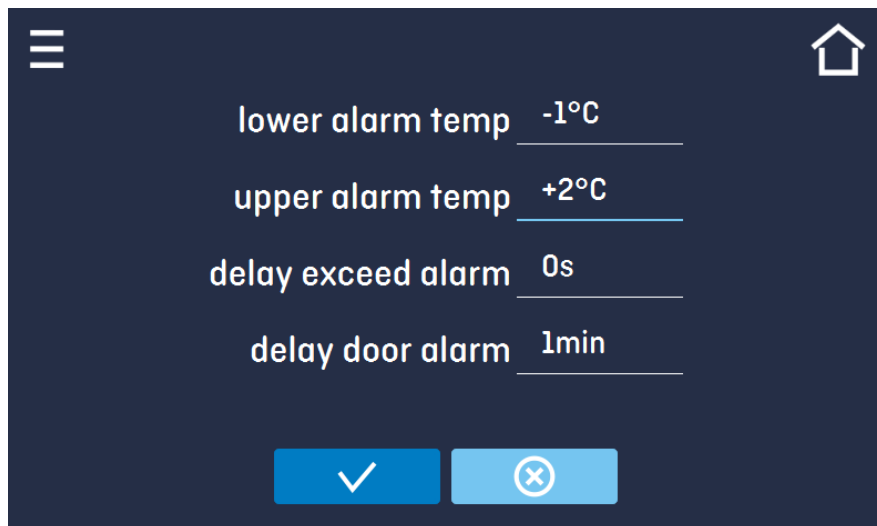

Confirms and saves changes



Cancel the entered changes



In the field "lower alarm temp" you can set a value of -1°C to - 5°C and in the field "upper alarm temp" you can set a value of +1°C to +5°C.

5.14. Network

In this panel ([Figure 29](#)) you can change the settings for the LAN:

- **IP** – the device's IP address
- **Mask** – an Ethernet network mask to which the device is connected
- **Gate** – Server's IP address or router's that manages the Ethernet network
- **DNS** – IP address of the domain name system
- **MAC** – the address of the network card, read-only
- **DHCP** – you can select if the server that allocates IP addresses is running on the local network.

You can then skip setting IP, Masks, Gates

Icon **A** indicates the connection status.



Device connect



Device disconnect

Figure 29 – LAN settings



Confirms and saves changes



Cancel the entered changes

5.15. Corrections

In this window (*Figure 30*) you can set correct:

- The temperature indicated on the display by adding the correction value. The set correction value is taken in the whole temperature range operation of the device. For example, if the average temperature displayed by the device indicates 100°C and the average temperature measured by independent, external sensor indicates 100,5°C, the correction should be set on +0,5°C. The average temperature should be calculated from chosen period of time e.g. 30 min. The correction range of -5°C to +5°C.



The device has been calibrated by the manufacturer in accordance with applicable norms. The temperature shown on the display corresponds with a great accuracy to the temperature in the geometrical centre of the chamber. For the correct operation of the device it is not necessary to use User's calibration.

The User is performing temperature correction on his own responsibility and s/he must be aware of consequences of changing of manufacturer's settings. If the equipment was calibrated, calibration certificate loses its validity.

Figure 30 – correction inputted by the User

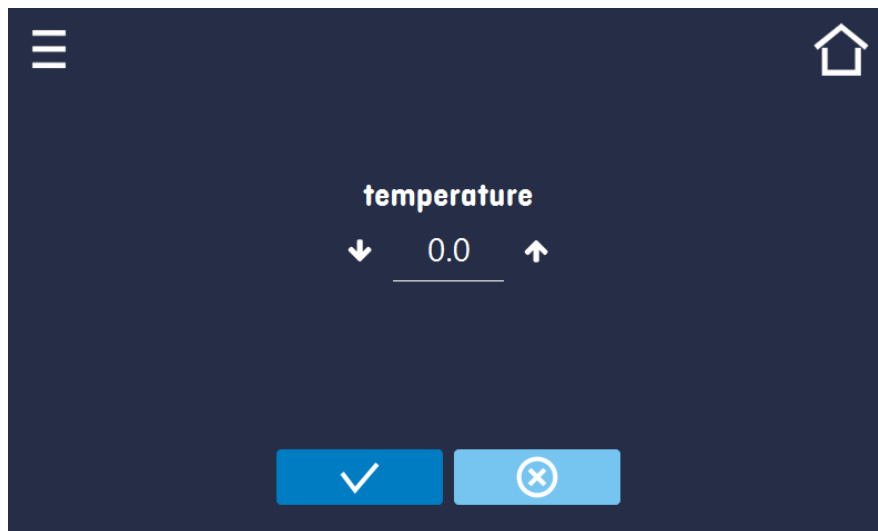

Confirms and saves changes



Cancels the entered changes

6. COMPONENTS OF THE UNIT

6.1. Internal glass door (only for INCU-Line)

To open or close the internal glass door use the plastic handle installed on the glass. While operating the unit at high temperatures, do not touch the glass door or inner parts of the chamber. Always use safety gloves to protect yourself and minimise the risk of getting burnt.

6.2. Door lock

All models have been equipped with a door lock located in the door handle. Two keys are attached on the backside of the device.



6.3. Access port

A Ø30 mm access port can be used to insert an external temperature sensor, which has been secured with a silicon plug. The plug should cover the access port while the unit is operating. If multiple cables have been inserted through the access port and if it is not possible to use the plug, secure the access port with adhesive tape. If you leave the access port open, it may affect temperature stability and uniformity within the chamber.



6.4. Open door alarm

All incubators have been equipped with an open door sensor. If you open the door, icon:



appear on the display.

If you leave the door open for more than 60 seconds, an alarm will sound and the control bar will be red. The alarm event "door open" is displayed in the list, with the status alarm active.



Open door sensor

6.5. USB port

To transfer data from the unit's memory to the USB memory stick, connect the memory stick to the USB slot on the device.

Go to Main Menu → Data record, press the button



Select file type *.csv, *.plx.

Press:



Data is copied.

Data saved as *.csv file can be opened in the Notepad. Data saved as *.plx file can be opened only by optional available Premium Control Software. This program allows you f. ex. to view the data in the table as a graph. It allows you to make a report of selected data range.

Figure 31 – Export

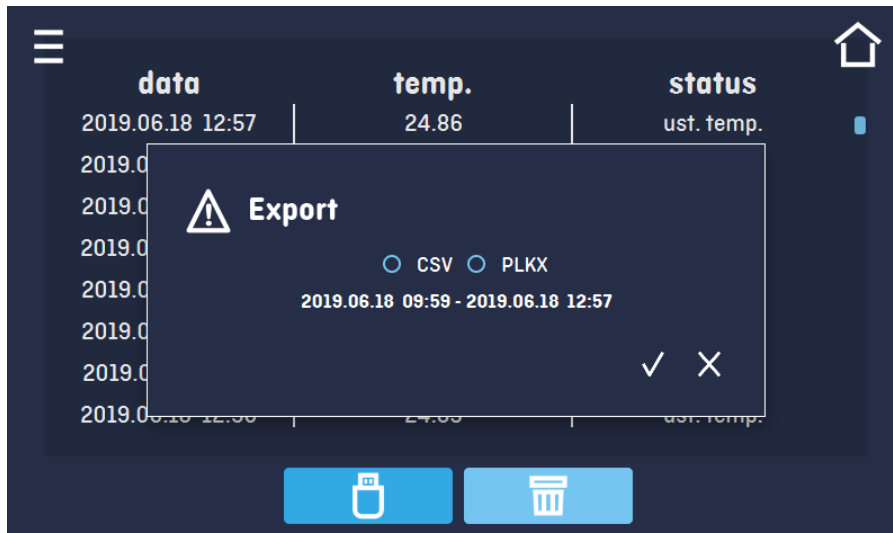

7. TEMPERATURE PROTECTION

Temperature protection is included as standard, if damage occurs to the temperature controller or the User changes the temperature settings outside of the limit, temperature protection will activate.

Protection class 3.1 is a standard. The figure below shows how this works.

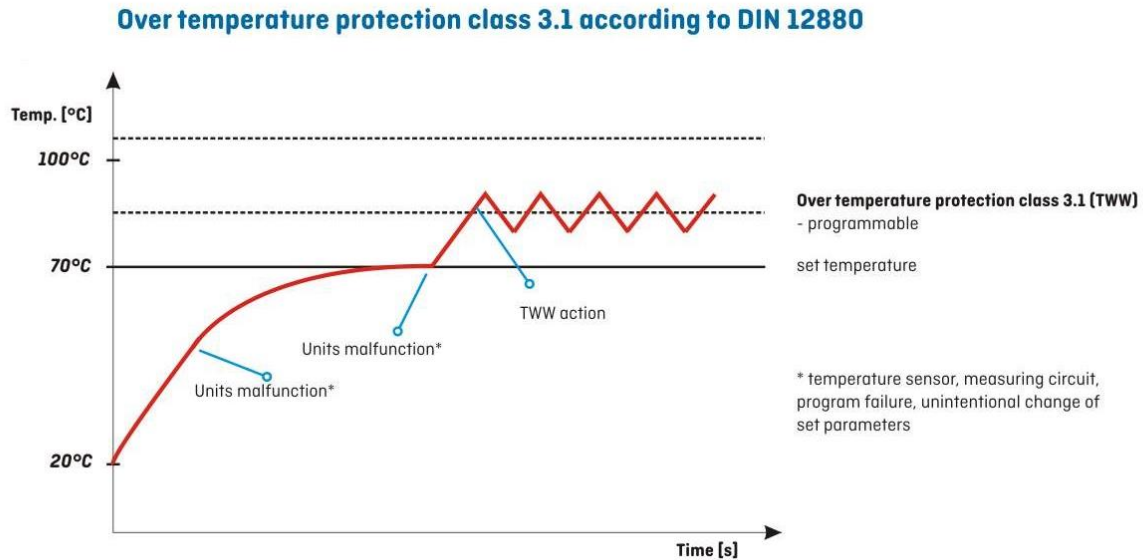

Protection Class 3.1 according to DIN 12880 norm is called protecting sample function. The User can set the temperature protection (upper limit) by himself and when the set temperature falls outside of this range, the power heater is switched off. When the temperature returns to within normal parameters, the device continues to work normally.

8. REMOTE CONTROL OF THE UNIT

All Prime models can be connected to a computer via Ethernet and monitored remotely but not remotely controlled with the Premium Control software (option). The functions of the software are described in a separate operating manual.

9. CLEANING AND MAINTENANCE OF THE UNIT



Before cleaning the device, it needs to be disconnected from the electrical supply!



Always use safety gloves while cleaning to avoid the risk of injury due to any sharp edges.

To clean products made of stainless steel we recommend using cleaning solution dedicated particularly to stainless steel material. It preserves the steel surface from permanent stains and at the same time retains aesthetic appearance of the product.

INOX products are manufactured with stainless steel. When used in standard laboratory conditions they do not rust. However it is possible that stains (which may look like rust) form on the steel surface (e.g. due to the kind of samples that are incubated in the chamber). In such case we recommend using cleaning solution (to clean the stains) which is dedicated to this particular application, e.g. Pelox.



When cleaning stainless steel product with dedicated cleaning solution, one should pay attention to the suggestions and recommendations given in the instruction manual (or in the safety data sheet) of the cleaning solution.

9.1. Exterior cleaning

1.	The housing of the device should be cleaned at least once a week, depending on the working conditions.
2.	The housing and door should be cleaned with caution using a soft cloth dampened with water.
3.	Only mild cleaning products should be used to clean the device.
4.	Electrical parts should not get in contact with water or detergent.
5.	Clean the touch screen using a soft cloth for touch screens, or it is possible to use foam for cleaning touch screens.
6.	USB port can be cleaned with a vacuum cleaner to prevent accumulation of dirt inside the socket.

9.2. Interior cleaning

1.	The chamber should be emptied of any samples before cleaning.
2.	Open the door of the device and wait till the chamber has cooled down, take out the shelves and start cleaning the device.
3.	Only water or water with mild detergent should be used.
4.	Having finished cleaning, you should allow the device to dry fully and fit all parts removed before cleaning.
5.	During cleaning you should make sure not to damage the temperature sensor built in on the top of the chamber.
6.	In drying oven could happened the internal bottom metal part becomes discoloured. It is caused be very high heaters temperature which are placed just under bottom metal part.

10. ADVICE ON HOW TO SAFELY STORE THE UNIT

1.	Remove all objects from the chamber.
2.	Disconnect the device from the mains.
3.	Clean and dry the chamber.
4.	Leave the door open to allow adequate ventilation.
5.	Store in temperatures between 0°C and 50°C and relative humidity maximum 70%.

11. TROUBLESHOOTING

Before you contact VWR Service Department:

1.	Make sure that the operation complies with the instruction manual of the device.
2.	Restart the device to make sure that the unit is not functioning properly. If it still does not work, disconnect the unit again from the mains and repeat the operation after one hour.

Technical service

Visit the VWR's website at www.vwr.com for:

- Complete technical service contact information
- Access to VWR's Online Catalogue, and information about accessories and related products
- Additional product information and special offers

Contact us for information or technical assistance contact your local VWR representative or visit

www.vwr.com

11.1. Possible defects

Malfunction	What to check	What to do
The unit is not working	Check the voltage in the socket	Measure the voltage in the socket; if necessary, change the fuses in the electric installation in the building
	Check if the unit is plugged in	Plug in the unit
	Check the status of a circuit-breaker on the back of the device	Press the circuit breaker on the back of the device.
	Check if the power cable is broken	Change the cable
The unit is not heating up	Check if the door of the unit is closed properly	Clean the gasket
	Check if the fan is turned on	If not please contact service
	Does the installation site meet the installation conditions?	Adapt to the installation requirements on site (according to point 3 chapter 1)
The unit is working too loudly	Check if the unit is not touching other objects (e.g. furniture etc.)	Remove other objects
	Check if the doors are properly leveled	If the doors are correctly leveled and still are sagging, please contact service

12. WARRANTY CONDITIONS

VWR International warrants that this product will be free from defects in material and workmanship for a period of two (2) years from date of delivery. If a defect is present, VWR will, at its option and cost, repair, replace, or refund the purchase price of this product to the customer, provided it is returned during the warranty period. This warranty does not apply if the product has been damaged by accident, abuse, misuse, or misapplication, or from ordinary wear and tear. If the required maintenance and inspection services are not performed according to the manuals and any local regulations, such warranty turns invalid, except to the extent, the defect of the product is not due to such non-performance.

Items being returned must be insured by the customer against possible damage or loss. This warranty shall be limited to the aforementioned remedies. IT IS EXPRESSLY AGREED THAT THIS WARRANTY WILL BE IN LIEU OF ALL WARRANTIES OF FITNESS AND IN LIEU OF THE WARRANTY OF MERCHANTABILITY.

Compliance with local laws and regulations

The customer is responsible for applying for and obtaining the necessary regulatory approvals or other authorizations necessary to run or use the Product in its local environment. VWR will not be held liable for any related omission or for not obtaining the required approval or authorization, unless any refusal is due to a defect of the product.

13. PRODUCT IDENTIFICATION LABEL



The product identification label is located in the upper left corner.

Below there is an example of product identification label:



1. Logo
2. Type of device
3. Catalogue number
4. Serial number
5. CE mark
6. Name and address of manufacturer
7. Bar code
8. UKCA mark and UK Importer

14. TECHNICAL DETAILS

		DL 56 PRIME	DL 112 PRIME	DL 180 PRIME
				
Air convection		Natural		
Chamber capacity [l]		56	112	180
Door type		solid		
Temperature range [°C]		+50...+300		
Temperature resolution [°C]		Every 0,1		
Controller		Microprocessor with a 4,3" full colour touch screen		
Interior		Stainless steel to DIN 1.4301		
Housing		Powder coated sheet		
Overall dims ¹⁾ [mm]	A width	590	650	650
	B height	700	850	1030
	C depth	600	700	760
Internal dims [mm]	D width	400	460	470
	E height	390	540	720
	F depth	360	450	560
Max shelf workload [kg]		25	25	25
Max unit workload [kg]		50	50	75
Nominal power [W]		1700	2500	2800
Weight [kg]		52	65	86
Temperature fluctuation ²⁾ at 150°C [°C]		+/-0,4	+/-0,4	+/-0,4
Temperature variation ³⁾ at 150°C [°C]		+/-3,3	+/-3,0	+/-3,5
Powers supply		230V 50Hz		
Shelves (fitted/max)		2/5	2/7	3/9
Warranty		24 months		

¹⁾ depth doesn't include 50 mm of power cable



²⁾ fluctuation measured in centre of the chamber

³⁾ in space, variation (K) calculated for chamber

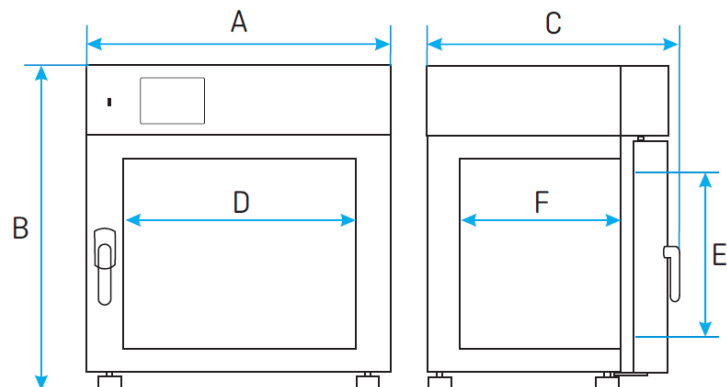
$$\text{as: } K = \pm \frac{\bar{T}_{max} - \bar{T}_{min}}{2}$$



Instruction Manual DL, VL, IL Prime

		VL 56 PRIME	VL 112 PRIME	VL 180 PRIME
				
Air convection		forced		
Chamber capacity [l]		56	112	180
Door type		solid		
Temperature range [°C]		+50...+300		
Temperature resolution [°C]		every 0,1		
Controller		Microprocessor with a 4,3" full colour touch screen		
Interior		Stainless steel to DIN 1.4301		
Housing		Powder coated sheet		
Overall dims ¹⁾ [mm]	A width	590	650	650
	B height	700	850	1030
	C depth	600	700	760
Internal dims [mm]	D width	400	460	470
	E height	390	540	720
	F depth	360	450	560
Max shelf workload [kg]		25	25	25
Max unit workload [kg]		50	50	75
Nominal power [W]		1700	2500	2800
Weight [kg]		53	66	87
Temperature fluctuation ²⁾ at 150°C [°C]		+/-0,2	+/-0,2	+/-0,2
Temperature variation ³⁾ at 150°C [°C]		+/-2,0	+/-2,3	+/-2,5
Powers supply		230V 50Hz		
Shelves (fitted/max)		2/5	2/7	3/9
Warranty		24 months		

¹⁾ depth doesn't include 50 mm of power cable



²⁾ fluctuation measured in centre of the chamber

³⁾ in space, variation (K) calculated for chamber

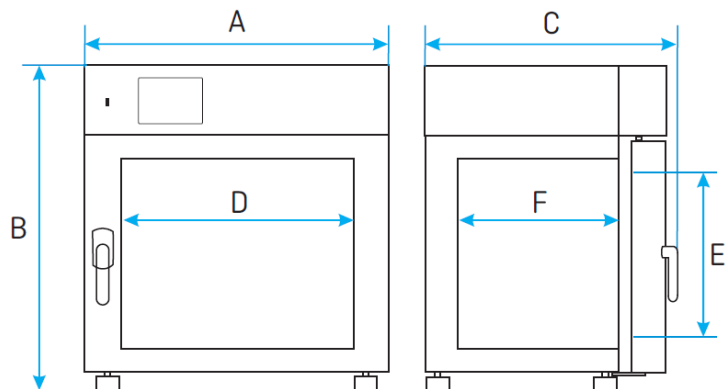
$$\text{as: } K = +/\frac{T_{max}-T_{min}}{2}$$



Instruction Manual DL, VL, IL Prime

		<i>IL 56 PRIME</i>	<i>IL 112 PRIME</i>	<i>IL 180 PRIME</i>
				
Air convection		Natural		
Chamber capacity [l]		56	112	180
Door type		Double (external solid, internal glass)		
Temperature range [°C]		+5 above ambient temperature...+100		
Temperature resolution [°C]		Every 0,1		
Controller		Microprocessor with a large 4,3" full colour touch screen		
Interior		Stainless steel to DIN 1.4016		
Housing		Powder coated sheet		
Overall dims ¹⁾ [mm]	A width	590	650	650
	B height	700	850	1030
	C depth	600	700	760
Internal dims [mm]	D width	400	460	470
	E height	390	540	720
	F depth	360	450	560
Max shelf workload [kg]		25	25	25
Max unit workload [kg]		50	50	75
Nominal power [W]		450	450	650
Weight [kg]		54	67	88
Temperature fluctuation ²⁾ at 37°C [°C]		+/-0,2	+/-0,2	+/-0,2
Temperature variation ³⁾ at 37°C [°C]		+/-0,7	+/-0,6	+/-0,8
Powers supply		230V 50Hz		
Shelves (fitted/max)		2/5	2/7	3/9
Warranty		24 months		

¹⁾ depth doesn't include 50 mm of power cable

²⁾ fluctuation measured in centre of the chamber

³⁾ in space, variation (K) calculated for chamber

$$\text{as: } K = +/\frac{T_{max}-T_{min}}{2}$$

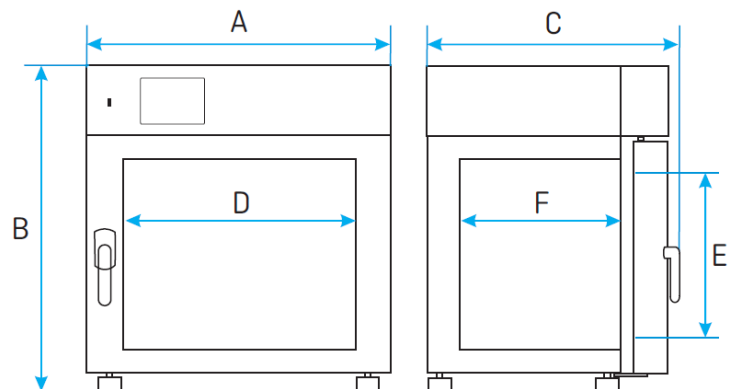

Your Distributor

Austria

VWR International GmbH
Graumannsgasse 7
1150 Vienna
Tel.: +43 01 97 002 0
Email: info.at@vwr.com

Belgium

VWR International bv
Researchpark Haasrode 2020
Geldenaaksebaan 464
3001 Leuven
Tel.: +32 016 385 011
Email: vwr.be@vwr.com

China

VWR (Shanghai) Co., Ltd
Bld.No.1, No.3728 Jinke Rd,
Pudong New District
Shanghai, 201203- China
Tel.: 400 821 8006
Email: info_china@vwr.com

Czech Republic

VWR International s. r. o.
Veetee Business Park
Pražská 442
CZ - 281 67 Stříbrná Skalice
Tel.: +420 321 570 321
Email: info.cz@vwr.com

Denmark

VWR International A/S
Tobaksvejden 21
2860 Søborg
Tel.: +45 43 86 87 88
Email: info.dk@vwr.com

Finland

VWR International Oy
Valimotie 17-19
00380 Helsinki
Tel.: +358 09 80 45 51
Email: info.fi@vwr.com

France

VWR International S.A.S.
Immeuble Estréo
1-3 rue d'Aurion
93114 Rosny-sous-Bois cedex
Tel.: 0 825 02 30 30* (national)
Tel.: +33 (0) 1 45 14 85 00 (international)
Email: info.fr@vwr.com
* 0,18 € TTC/ min + prix appel

Germany

VWR International GmbH
Hilpertstraße 20a
D - 64295 Darmstadt
Freecall: 0800 702 00 07
Tel.: +49 (0) 6151 3972 0 (international)
Email: info.de@vwr.com

Hungary

VWR International Kft.
Simon László u. 4.
4034 Debrecen
Tel.: +36 (52) 521-130
Email: info.hu@vwr.com

India

Avantor Performance Materials India
Limited
17th Floor, Building No. 5, Tower C
DLF Cyber City Phase – III
Gurgaon - 122002, Haryana
Tel.: +91-1244-65-6700
help@avantoric.com

Ireland

VWR International Ltd
Orion Business Campus
Northwest Business Park
Ballycoolin
Dublin 15
Tel.: +353 01 88 22 222
Email sales.ie@vwr.com

Italy

VWR International S.r.l.
Via San Giusto 85
20153 Milano (MI)
Tel.: +39 02-3320311
Email: info.it@vwr.com

Korea

VWR International ~
17, Daehak 4-ro, Yeongtong-gu,
Suwon-si, Gyeonggi-do
Tel.: +82 31 645 7256
saleskorea@avantorsciences.com

Middle East & Africa

VWR International FZ-LLC
DSP Laboratory Complex
125, Floor 01
Dubai, United Arab Emirates
Tel.: +971 4 5573271
info.mea@vwr.com

The Netherlands

VWR International B.V.
Postbus 8198
1005 AD Amsterdam
Tel.: +31 020 4808 400
Email: info.nl@vwr.com

Norway

VWR International AS
Brynsalleen 4
0667 Oslo
Tel.: +47 22 90 00 00
Email: info.no@vwr.com

Poland

VWR International Sp. z o.o.
Limbowa 5
80-175 Gdansk
Tel.: +48 058 32 38 200
Email: info.pl@vwr.com

Portugal

VWR International –
Material de Laboratório, Lda
Centro Empresarial de Alfragide
Rua da Indústria, nº 6
2610-088 Amadora
Tel.: +351 21 3600 770
Email: info.pt@vwr.com

Singapore

VWR Singapore Pte Ltd
18 Gul Drive
Singapore 629468
Tel: +65 6505 0760
Email: sales.sg@vwr.com

Spain

VWR International Eurolab S.L.U.
C/ Tecnología 5-17
A-7 Llinars Park
08450 - Llinars del Vallès
Barcelona
Tel.: +34 902 222 897
Email: info.es@vwr.com

Sweden

VWR International AB
Fagerstagatan 18a
163 94 Stockholm
Tel.: +46 08 621 34 00
Email: info.se@vwr.com

Switzerland

VWR International AG
Lerzenstrasse 16/18
8953 Dietikon
Tel.: +41 044 745 13 13
Email: info.ch@vwr.com

UK

VWR International Ltd
Customer Service Centre
Hunter Boulevard
Magna Park
Lutterworth
Leicestershire
LE17 4XN
Tel.: +44 (0) 800 22 33 44
Email: uksales@vwr.com