

Horizontal Electrophoresis System

Model D4

Operating and Maintenance Manual 7007325 Rev. 0

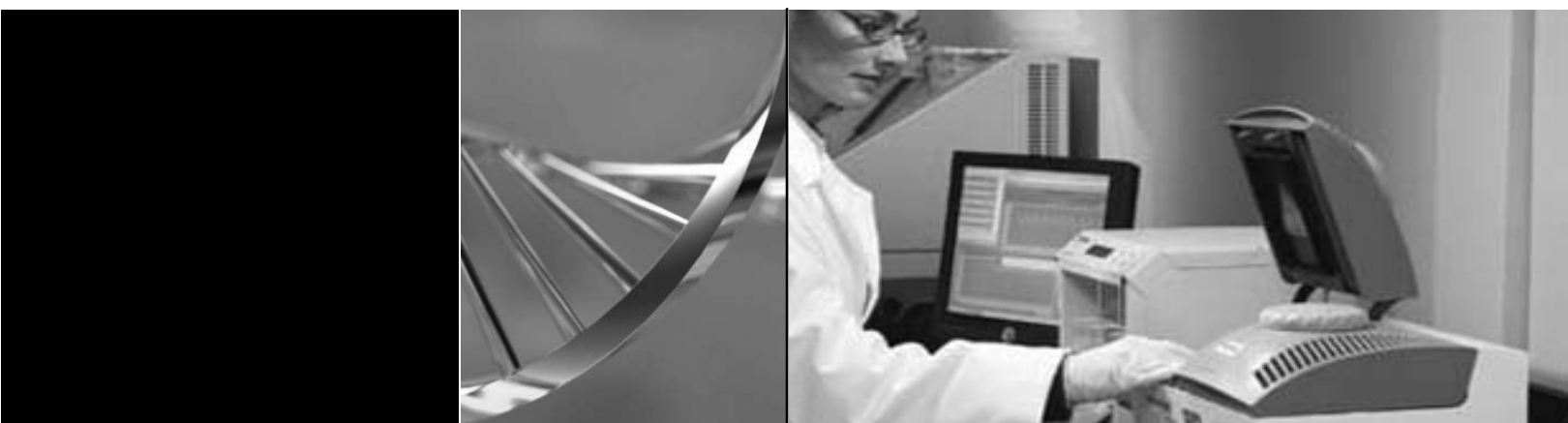

Visit us online to register your warranty
www.thermoscientific.com/warranty





MANUAL NUMBER 7007325

0	--	4/9/12	Transferred to Marietta (was Rev Date 11/2002)	ccs
REV	ECR/ECN	DATE	DESCRIPTION	By



Important Read this instruction manual. Failure to read, understand and follow the instructions in this manual may result in damage to the unit, injury to operating personnel, and poor equipment performance. ▲

Caution All internal adjustments and maintenance must be performed by qualified service personnel. ▲

Material in this manual is for information purposes only. The contents and the product it describes are subject to change without notice. Thermo Fisher Scientific makes no representations or warranties with respect to this manual. In no event shall Thermo be held liable for any damages, direct or incidental, arising out of or related to the use of this manual.

©2012 Thermo Fisher Scientific. All rights reserved.



Important operating and/or maintenance instructions. Read the accompanying text carefully.



Potential electrical hazards. Only qualified persons should perform procedures associated with this symbol.



Equipment being maintained or serviced must be turned off and locked off to prevent possible injury.



Hot surface(s) present which may cause burns to unprotected skin, or to materials which may be damaged by elevated temperatures.



Marking of electrical and electronic equipment, which applies to electrical and electronic equipment falling under the Directive 2002/96/EC (WEEE) and the equipment that has been put on the market after 13 August 2005.



This product is required to comply with the European Union's Waste Electrical & Electronic Equipment (WEEE) Directive 2002/96/EC. It is marked with the WEEE symbol. Thermo Fisher Scientific has contracted with one or more recycling/disposal companies in each EU Member State European Country, and this product should be disposed of or recycled through them. Further information on Thermo's compliance with this directive, the recyclers in your country and information on Thermo products will be available at www.thermofisher.com.

- ✓ Always use the proper protective equipment (clothing, gloves, goggles, etc.)
- ✓ Always dissipate extreme cold or heat and wear protective clothing.
- ✓ Always follow good hygiene practices.
- ✓ Each individual is responsible for his or her own safety.

Do You Need Information or Assistance on Thermo Scientific Products?

If you do, please contact us 8:00 a.m. to 6:00 p.m. (Eastern Time) at:

1-740-373-4763

1-800-438-4851

1-877-213-8051

<http://www.thermoscientific.com>

service.led.marietta@thermofisher.com

www.unitylabservices.com

Direct

Toll Free, U.S. and Canada

FAX

Internet Worldwide Web Home Page

Tech Support Email Address

Certified Service Web Page

Our **Sales Support** staff can provide information on pricing and give you quotations. We can take your order and provide delivery information on major equipment items or make arrangements to have your local sales representative contact you. Our products are listed on the Internet and we can be contacted through our Internet home page.

Our **Service Support** staff can supply technical information about proper setup, operation or troubleshooting of your equipment. We can fill your needs for spare or replacement parts or provide you with on-site service. We can also provide you with a quotation on our Extended Warranty for your Thermo Scientific products.

Whatever Thermo Scientific products you need or use, we will be happy to discuss your applications. If you are experiencing technical problems, working together, we will help you locate the problem and, chances are, correct it yourself...over the telephone without a service call.

When more extensive service is necessary, we will assist you with direct factory trained technicians or a qualified service organization for on-the-spot repair. If your service need is covered by the warranty, we will arrange for the unit to be repaired at our expense and to your satisfaction.

Regardless of your needs, our professional telephone technicians are available to assist you Monday through Friday from 8:00 a.m. to 6:00 p.m. Eastern Time. Please contact us by telephone or fax. If you wish to write, our mailing address is:

Thermo Fisher Scientific
401 Millcreek Road, Box 649
Marietta, OH 45750

International customers, please contact your local Thermo Scientific distributor.

Table of Contents

Section 1	Introduction	1-1
Section 2	Safety Information	2-1
Section 3	Unpack and Check Your Order	3-1
	Casting Two Gels	4-1
Section 4	Setting Up	4-1
	Casting Two Gels	4-1
	Casting One Gel	4-4
Section 5	Using the System	5-1
	Finishing Up	5-4
Section 6	Care and Cleaning	6-1
Section 7	Reagents Information	7-1
Section 8	Troubleshooting	8-1
Section 9	Optional Equipment	9-1

Section 1 Introduction

The Owl Horizontal Agarose Gel Electrophoresis System is designed to provide flat, even banding patterns and consistent results with hassle-free gel casting. No tape, grease, agarose seals or other accessories are required. The model D4's design allows you to run one gel tray (51 samples) or two gel trays (102 samples) while saving valuable bench space. Each of the (2) UVT (Ultra Violet Transmissible) gel trays, 16cmWx 17cmL, accommodates up to (3) combs, allowing the user to run up to 3 series of samples of equal distances. A stand-alone casting platform is included for casting 2 gels simultaneously. A single gel can be cast right in the buffer chamber. Custom combs are available upon request.

Section 2 Safety Information

Warning Please read carefully before operating! ▲

- To avoid the risk of personal shock, always disconnect the gel box from the power supply. Further, the power supply must be equipped with a shutdown-on-disconnect circuit.
- Statement of Proper Use: Use this product only for its intended purpose as described in this manual. Do not use this product if the power leads are damaged or if any of its surfaces are cracked.
- Running conditions for this unit should not exceed the name plate readings found on the lower buffer chamber.
- Do not move the unit unless the power source to the unit has been disconnected.

Section 3 Unpack and Check Your Order

Before starting, unpack the unit and inventory your order. If any parts are missing, contact Technical Services within 48 hours.

Reference the order or catalog number on your invoice and check the corresponding part lists:

Item	Part No.	Description	Qty
1.	n/a	Buffer Chamber	1
2a.	D4-LID	Supersafe™ Lid	1
2b.	PSL-5	Attached Power Supply Leads (1 pair)	1
3a.	D4-UVT	EasyCast™ Gasketed UVT Gel Trays, 16cm W x 17cm L	2
3b.	D4-GK	Gaskets (1 pair)	2
4.	D4-17d	Comb, 1.5mm thick, 17 tooth (includes one marker lane)	6
5a.	D4-CST	External Casting Chamber	1
5b.	BBL-1	Bubble Level	1

Optional: 2 Buffer Exchange Ports (for D4-BP model only), see page 14.

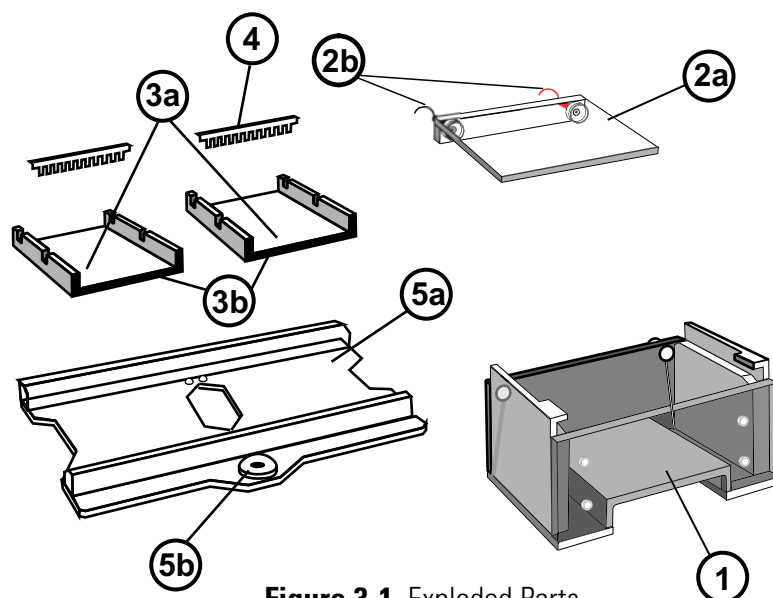

Figure 3-1. Exploded Parts

Section 3

Unpack and Check Your Order

Table 3-1. Specifications and Recommended Running Conditions for Model D4

Gel size (W x L cm)	16 x 17	
Buffer capacity	800	1 tray
	1600	2 trays
Voltage requirements (V)	100V minimum	
Time requirements	4½ hours	

Section 4 Setting Up

There are two casting options with the D4 system. The first option is Casting Two Gels simultaneously in the external casting chamber. The second option is Casting One Gel within the buffer chamber.

There are two comb options available with the D4 Gel Tray. The first option allows 17 samples with a 16.4cm run length or the second option allows 51 samples with a 5.2cm run length (Figure 4-1).

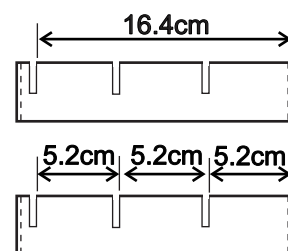

Figure 4-1. Combs

Casting Two Gels

1. Remove the SuperSafe™ lid from the gel box by holding the front of the buffer chamber and pulling the lid off by holding the center of the back of the lid or pressing your thumbs on both sides of the lid. The SuperSafe™ lid is attached to the unit at the connection of the power cords to the banana plugs.
2. For shipping and convenient storage, the gel trays are packaged inside the casting chamber (Figure 4-2). To remove the gel trays, hold the casting chamber firmly with one hand; grasp the long sides of the UVT gel tray and pull up slowly at an angle with your other hand. The trays fit snugly for leak proof gel casting; therefore they may be tight. “Walking” the tray upwards at an angle may be helpful. The tightness will diminish, the more the unit is used.
3. To cast two gels, place the gel trays into the casting chamber (Figure 4-2), so the gasketed ends press against the walls of the casting chamber. Make sure the gel tray is pressed all the way down and rests level on the platform. The bubble in the bubble level should rest in the center circle. To level the casting chamber, adjust the leveling screws on the front of the casting chamber (the third screw is for balance) until the bubble is in the center circle.

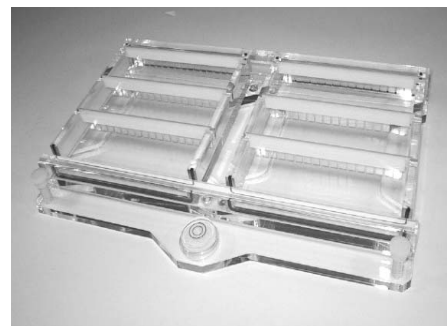

Figure 4-2. Casting Gels

Casting Two Gels (continued)

4. Preparing the gel(s) - The percentage of agarose and the buffer used is determined by the size of the samples to be separated and further recovery of the samples (see Tables 4-1, 4-2 and 4-3). The agarose and buffer are mixed and heated over a heat source, in a microwave oven, or in an autoclave until the agarose is completely dissolved. The prepared gel solution then must be cooled to below 60°F before casting to avoid warping the UVT gel tray(s). If numerous gels are to be run in one day, a large volume of gel solution may be prepared and placed in a covered bottle stored between 40-60°F in a water bath. This provides a ready gel supply in a warm liquid form that will solidify quickly when gels are cast.
5. Pour or pipette (Figure 4-3) the appropriate amount (see Table 4-2) of warm agarose (<60°F) onto the UVT gel tray that has been placed into the casting position in the casting chamber. Immediately after pouring, insert the desired comb or combs into the comb slots to form the sample wells. Repeat with second gel tray if casting (2) gels. Allow the gel(s) to solidify completely. If a short running distance is required for proper sample separation, then 3 combs may be used. This expands the number of samples per run.

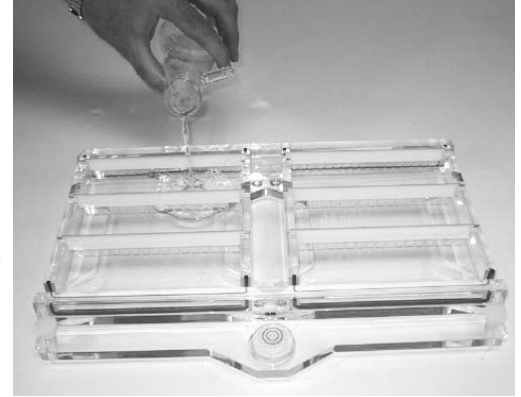

Figure 4-3. Pour/Pipette Agarose

Table 4-1. Mobility range of DNA in different percentage agarose gels

Agarose % (w/v)	Approximate range of separated DNA fragments (kb)
0.3	60 to 5
0.5	30 to 1
0.7	12 to 0.8
1.0	10 to 0.5
1.2	7 to 0.3
1.5	4 to 0.2
2.0	3 to 0.1
3.0	<0.1

Table 4-2. Amount of Agarose to prepare

Gel volume is determined by the following formula and may be adjusted according to need or preference:

$$\text{gel width(cm)} \times \text{gel length (cm)} \times \text{gel thickness (cm)} = \text{ml of agarose}$$

Width of Gel (cm)	Length of Gel (cm)	Thickness of Gel (cm)	Volume of Gel (ml)
15.6	17.3	1.0	271
15.6	17.3	0.75	203
15.6	17.3	0.50	13

Table 4-3. Sample Volume

D4 unit - volumes of comb wells

Part No.	# of Teeth	Thickness of tooth-mm	Width of tooth-mm	Recommended loading volume (ul)*			
				0.25cm	0.5cm	0.75cm	1.0cm
D4-17C	17	1.0	7.2	5	19	32	46
D4-17D	17	1.5	7.2	8	28	49	69

**For different thicknesses of gel*

Casting One Gel

One (1) gel may be cast directly in the buffer chamber of the device.

1. Remove the SuperSafe™ lid from the gel box by holding the front of the buffer chamber and pulling the lid off by holding the center of the back of the lid or pressing your thumbs on both sides of the lid. The SuperSafe™ lid is attached to the unit at the connection of the power cords to the banana plugs.
2. Place the UVT gel tray into the buffer chamber in the casting position (Figure 4-4). Immediately after pouring the appropriate amount of agarose (<60°F), onto the UVT gel tray, insert the desired comb or combs into the comb slots to form the sample wells. Once gel is ready to run, place the tray in the running position (Figure 4-5).



Figure 4-4. Casting Position

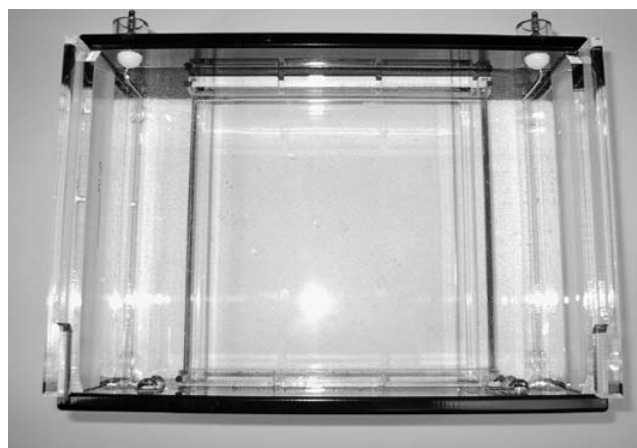

Figure 4-5. Running Position

3. Preparing the gel(s) - The percentage of agarose and the buffer used is determined by the size of the samples to be separated and further recovery of the samples (see Tables 4-1, 4-2 and 4-3). The agarose and buffer are mixed and heated over a heat source, in a microwave oven, or in an autoclave until the agarose is completely dissolved. The prepared gel solution then must be cooled to below 60°F before casting to avoid warping the UVT gel tray(s). If numerous gels are to be run in one day, a large volume of gel solution may be prepared and placed in a covered bottle stored between 40-60°F in a water bath. This provides a ready gel supply in a warm liquid form that will solidify quickly when gels are cast.
4. Pour or pipette (Figure 4-3) the appropriate amount (see Table 4-2) of warm agarose (<60°F) onto the UVT gel tray that has been placed into the casting position in the casting chamber. Immediately after pouring, insert the desired comb or combs into the comb slots to form the sample wells. Repeat with second gel tray if casting (2) gels. Allow the gel(s) to solidify completely. If a short running distance is required for proper sample separation, then 3 combs may be used. This expands the number of samples per run.

Section 5 Using the System

Running Two Gels

1. Once the gels are completely solidified, lift one tray out of the casting chamber (Figure 5-1), and place it in the buffer chamber (Figure 5-2), with the first comb closest to the cathode (black) side of the chamber. The running position exposes the open ends of the gel tray and the agarose to the buffer. Standard agarose should solidify completely in about 30 minutes. If low melting point or a specialty agarose is used, consult the instructions supplied with the product.
2. To avoid damage to the sample wells, gently rock the comb back and forth lightly to loosen, then slowly pull the comb straight up out of the gel tray. This rocking helps to avoid suction as the comb is removed. Be sure to remove combs while immersed in buffer.
3. Follow Step 1 and 2, above, for the second gel tray.

Running One Gel

1. Once the gel is completely solidified, lift the gel tray out of the buffer chamber from the casting position and turn 90°, placing it back into the buffer chamber in the running position (see page 4, Figure 5 & 6). The running position exposes the open ends of the gel tray and the agarose to the buffer. Standard agarose should solidify completely in about 30 minutes. If low melting point or a specialty agarose is used, consult the instructions supplied with the product.

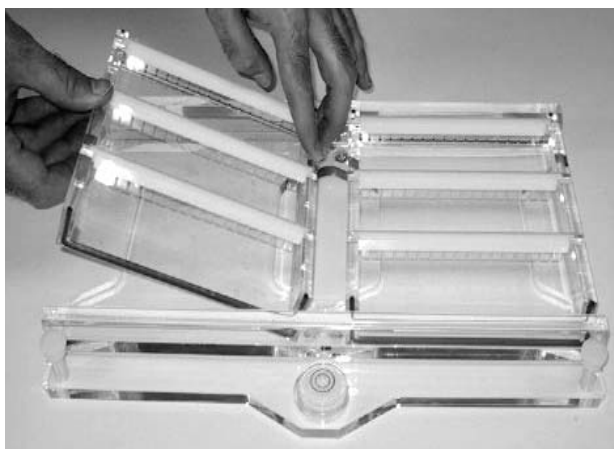

Figure 5-1. Casting Position

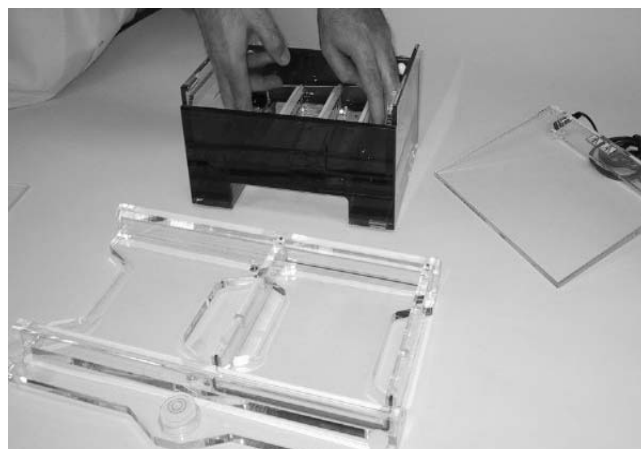

Figure 5-2. Running Position

Running One Gel (continued)

2. Carefully remove the comb (or combs) by tapping lightly to loosen (Figure 5-3), and slowly lifting out, away from the gel tray, to avoid damage to the wells.

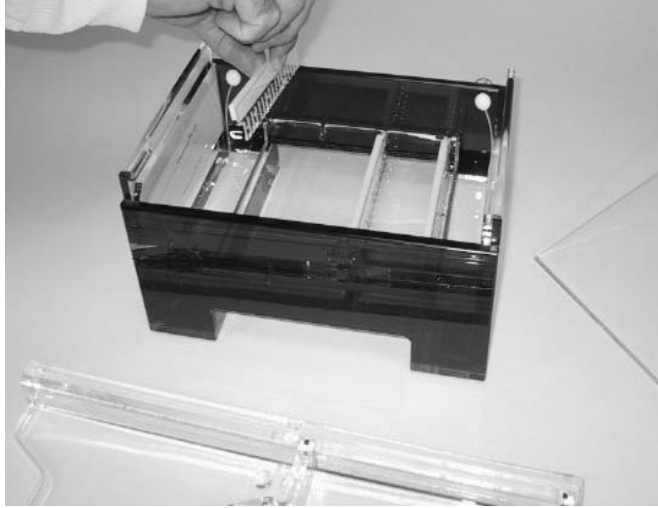

Figure 5-3. Carefully Remove Comb

3. Load the sample into the gel by using one of the following options.

Dry loading - Loading the sample in gel without the presence of buffer

- a. Remove the gel tray from the casting chamber.
- b. Load the sample into the gel but be careful not to puncture the bottom of the gel. Place the gel tray into the buffer chamber in the running position (see Figure 4-5).
- c. Remove the second gel tray from the casting chamber.
- d. Load the sample into the gel but be careful not to puncture the bottom of the gel. Place the gel tray into the buffer chamber in the running position (see Figure 4-5).
- e. Carefully fill the buffer chamber with buffer to cover either one tray (lower fill line) or both gel trays up to the upper fill line.

Note To run one gel, follow Steps a and b. Fill the buffer chamber with buffer to cover one gel tray to the lower fill line. ▲

Wet loading - Loading the sample in gel when it is submerged in buffer

- a. Remove one gel tray from the casting chamber.
- b. Place the gel tray into the buffer chamber in the running position.
- c. Pour running buffer into the unit to fill chamber and completely cover and submerge the gel. Two "Fill Lines" are located on each unit to clearly mark the correct buffer level. See Recommended Running Conditions (Table 3-1), for approximate buffer volumes needed for your unit. Too little buffer may cause the gel to dry out during the run, while excess buffer may slow DNA migration in the gel.
- d. Load prepared samples into the wells. Samples should be mixed with a sample loading buffer; giving weight to the samples so that they drop evenly into the wells, and contain tracking dye to monitor the gel run. See Table 4-2 for approximate well volumes.
- e. Remove the second tray from the casting chamber and put into the buffer chamber directly on top of the bottom tray. Add buffer to the second fill line. Continue to load samples.

Note To run one gel, follow Steps a, b, c and d. ▲

Note It is recommended to always run a sample lane of a known "standard ladder" or "marker" to determine concentration and size of separated fragments after the gel run, and to aid in photodocumentation and analysis. Migration patterns and fragment sizes for commonly used DNA molecular weight markers are shown in Figure 5-4. ▲

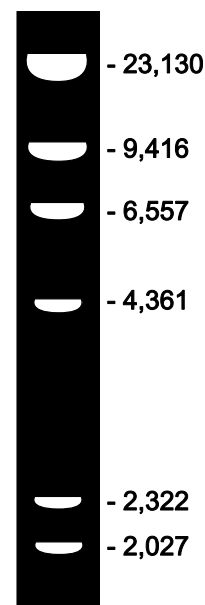

Figure 5-4. Sample Lane

- Carefully slide the Supersafe™ lid with attached power supply leads onto the unit (Figure 5-4). This will connect the power supply leads to the banana plugs to complete the circuit. Plug the other end of the power supply leads into an appropriate power supply.

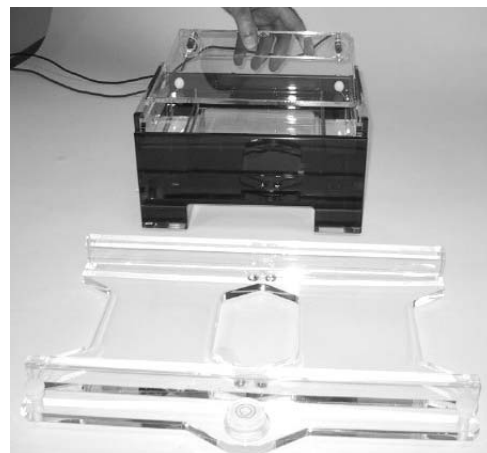

Figure 5-4. Install Lid

- Turn on power supply (See Recommended Running Conditions, Table 3-1). When the gel run is complete and tracking dye has migrated as far through the gel as desired or to the end of the gel, turn off the power supply and slide off the lid to disconnect the unit from the power source. Carefully remove the tray(s) containing the gel (wear gloves if ethidium bromide is present). The UVT gel tray makes visualization and photography with a UV light source easy without the need to remove the gel from the tray.

Finishing Up

When the gel run is complete and tracking dye has migrated as far through the gel as desired or to the end of the gel, turn off the power supply and slide off the lid to disconnect the unit from the power source. Carefully remove the tray(s) containing the gel (wear gloves if ethidium bromide is present). The UVT gel tray makes visualization and photography with a UV light source easy without the need to remove the gel from the tray.

Section 6 Care and Cleaning

Caution Do not use ethanol or other organic solvents to clean Owl products! Organic solvents cause acrylic to “craze” or crack. Clean all Owl acrylic systems with warm water and a mild detergent.

Do not autoclave, bake, or microwave your unit. Temperatures over 50°C can do damage to the acrylic. ▲

The unit may be rinsed with warm water, or cleaned with warm water and a mild detergent to get rid of any debris.

Note If an RNase free electrophoresis system is desired, there are various methods to rid the system of RNA contamination. For fast and easy decontamination, use RNase Away®*. Spray, wipe or soak labware with RNase Away® then wipe or rinse the surface clean; it instantly eliminates RNase. RNase Away® eliminates the old methods that include treatment with 0.1% Diethyl Pyrocarbonate (DEPC) treated water and soaking in dilute bleach. DEPC is suspected to be a carcinogen and should be handled with care. This electrophoresis system should never be autoclaved, baked, or placed in a microwave.

To order RNase Away®, contact Molecular BioProducts 800-995-2787 (U.S. and Canada) or 858-453-7551:

Part Number	Description
7000	250ml bottle
7002	475ml spray bottle
7003	1 liter bottle
7005	4 liter bottle

**Rnase AWAY® is a registered trademark of Molecular BioProducts*

Section 7 Reagents Information

Selection of Reagents for Gel Electrophoresis

1. Agarose

There are various types of agarose commercially available that may be used. Besides standard ultra pure electrophoresis grade agarose, there are also numerous low melting point products for easy sample recovery, as well as specialty products formulated for specific uses (i.e. to separate and/or recover very small or very large fragments).

Table 7-1. Mobility range of DNA in different percentage agarose gels

Agarose % (w/v)	Approximate range of separated DNA fragments (kb)
0.3	60 to 5
0.5	30 to 1
0.7	12 to 0.8
1.0	10 to 0.5
1.2	7 to 0.3
1.5	4 to 0.2
2.0	3 to 0.1
3.0	<0.1

Table 7-2. Amount of Agarose to prepare

Gel volume is determined by the following formula and may be adjusted according to need or preference:

$$\text{gel width(cm)} \times \text{gel length (cm)} \times \text{gel thickness (cm)} = \text{ml of agarose}$$

Width of Gel (cm)	Length of Gel (cm)	Thickness of Gel (cm)	Volume of Gel (ml)
15.6	17.3	1.0	271
15.6	17.3	0.75	203
15.6	17.3	0.50	13

Table 7-3. Sample Volume
D4 unit - volumes of comb wells

Part No.	# of Teeth	Thickness of tooth-mm	Width of tooth-mm	Recommended loading volume (ul)*			
				0.25cm	0.5cm	0.75cm	1.0cm
D4-17C	17	1.0	7.2	5	19	32	46
D4-17D	17	1.5	7.2	8	28	49	69

**For different thicknesses of gel*

Note. An increased agarose % provides better separation of small fragments and bands very close together that tend to be more difficult to separate. A specialty agarose product formulated to increase resolution of low molecular mass samples may also be used, or an agarose additive may be added to standard or low melting point agarose.

Example: A good mid-range gel percentage would be 0.7%, or 0.7g agarose in 100ml electrophoresis buffer (TBE or TAE), following heating and dissolving the agarose, 10ul of ethidium bromide stock solution (5mg/ml) is added. The gel would be run with compatible electrophoretic running buffer (1X TBE or 1X TAE) that also contained ethidium bromide. One liter of the running buffer would contain 100ul of this 5mg/ml ethidium bromide stock solution.

2. Ethidium Bromide

For photodocumentation of samples, the gel may be stained during or following the run with a variety of stains. The most common stain for DNA is ethidium bromide. Ethidium bromide may be added directly to the gel and running buffer to visualize and photograph the separated fragments following the gel run without the need for an additional staining step. The ethidium bromide is added to both the gel (after heating) and the electrophoresis buffer at a concentration of 0.5ug/ml. Conversely, the gel may be stained in a concentrated ethidium bromide solution after the gel run and rinsed for visualization.

Warning Ethidium bromide is a potential carcinogen. Care in handling the powder and stock solution must be taken. Always wear gloves when handling the powder, solutions and all gels that contain ethidium bromide.

Table 7-3. Preparation and Properties of TAE and TBE Electrophoresis Buffer Systems

These buffers are used because they both have a basic pH which gives the phosphate group of the DNA a net negative charge allowing migration of the DNA toward the positive anode in the electrophoresis chamber.

TAE - Tris Acetate with EDTA (40mM Tris Base, 40mM Acetic Acid, 1mM EDTA)	
50X stock solution, pH 8.5:	1X working solution:
242g Tris Base	40mM Tris Acetate
57.1ml Glacial Acetic Acid	1mM EDTA
18.61g Na EDTA " 2H ₂ O (MW 372.24)	
Distilled H ₂ O to 1 Liter Final Volume	
TBE - Tris Borate with EDTA (89mM Tris Base, 89mM Boric Acid, 2mM EDTA)	
10X stock solution:	1X working solution:
108g Tris Base	89mM Tris Base
55g Boric Acid	89mM Boric Acid
7.44g Na ₂ EDTA " 2H ₂ O (MW 372.24)	2mM EDTA
(or 40ml 0.5M EDTA, pH 8.0)	
Distilled H ₂ O to 1 Liter Final Volume	

Choose the buffer best suited to the experiment. Each buffer has different properties providing the necessary ions for electrophoretic migration.

<u>Buffer</u>	<u>Suggested Use</u>
TAE Buffer	<ul style="list-style-type: none">• Use when DNA is to be recovered• For electrophoresis of large (>20kb) DNA• Applications requiring high resolution• Has low ionic strength and low buffering capacity - recirculation may be necessary for long runs (>4hrs.)
TBE Buffer	<ul style="list-style-type: none">• General Purpose Buffer• Can be re-used• For electrophoresis of small (<1kb) DNA• Better resolution of small (<1kb) DNA• Decreased DNA mobility• High ionic strength and high buffering capacity - recirculation may not be required for extended run times• Reacts with the agarose making smaller pores and a tighter matrix. This reduces broadening of the DNA bands for sharper resolution.

3. Sample Buffer

Samples are prepared and mixed with sample buffer before being applied to the prepared gel. Sample buffers contain similar components to the running buffer, dyes for visibility, and glycerol to provide weight to the samples. This increased sample density ensures samples load evenly into the wells and do not float out during loading. Dyes also migrate toward the anode end of the electrophoresis chamber at predictable rates allowing the gel run to be monitored.

4. DNA Markers

Markers are run on each gel to monitor sample separation and to provide an accurate size estimation of the samples. By running a known marker of a specific concentration, the amount of the DNA can be estimated. These size markers are a suitable restriction digest of commonly available DNA.

Section 8 Troubleshooting

Problem	Solution
Agarose leaks into chamber when pouring gel	Check to see if the gasket is firmly seated in the grooves on the ends of the UVT gel tray. Reseat gasket if necessary by removing and rinsing under warm running water, then reseat evenly in the tray groove.
Bands seem to be running at an angle.	Check to be sure the casting is being done on a level surface. A leveling platform may be required. Make sure the gel tray is pressed all the way down and rests level on the casting chamber platform (the bubble in the bubble level should rest in the center circle). Adjust the leveling screws to make the casting chamber (D4-CST) level.
Samples seem to be running unevenly in certain areas.	Check to be sure the platinum electrode wire is intact and running evenly across the base of the chamber and up the side to the junction of the banana plug. If there appears to be a break in the electrode connection contact Technical Services immediately. This problem may also be caused by regular casting with very hot agarose gel (>60°F) which may damage the gel tray over time. Always cool the melted agarose to below 60°F before casting to avoid warping the UVT gel tray. Warping the gel tray will cause all subsequent gels to be cast unevenly.
Samples do not band sharply and appear diffuse in the gel.	Gels should be no more than 5mm thick and allowed to solidify completely before running. For standard agarose, this would be about 30 minutes, if low melting point agarose is used, it may be necessary to completely solidify gels at a cooler temperature in the refrigerator or cold room. Gels should be submerged in 3-5mm of buffer to avoid gel dry out, but excess buffer >5mm can cause decreased DNA mobility and band distortion.
Samples are not moving as expected through the gel, remaining in the wells, running "backwards" or diffusing into the gel.	Check to be sure that a complete power circuit is achieved between the unit and the power supply. Platinum wire and banana plugs should be intact. To test, simply fill the unit with running buffer and attach to the power supply without a gel or gel tray in the unit. The platinum wires on both sides of the unit should produce small bubbles as the current passes through. If a complete circuit does not exist, there will be little to no bubbles. Contact Technical Services to schedule a repair. Samples that appear to run backwards through the gel is caused by the tray being placed in the chamber in the reverse direction. The tray should be placed in the chamber with the comb at the edge of the tray closest to the cathode side of the chamber.

Section 8
Troubleshooting

Problem	Solution
When the comb is removed from the gel, the sample well is ripped and damaged.	Always make sure to allow the gel to solidify completely before moving the tray, unit, or removing the comb. To avoid damage to the sample wells, gently rock the comb back and forth lightly to loosen, then slowly pull the comb straight up out of the gel tray. This rocking helps to avoid suction as the comb is removed.
The gel seems to run slower under usual running conditions.	The volume of running buffer used to submerge the gel should only be between 3-5mm over the gel surface. The gel should be completely submerged to avoid the gel from drying out, which can smear the bands and possibly melt the gel due to overheating. If excessive running buffer is added the mobility of the DNA decreases and band distortion may result. Excess buffer causes heat to build up and buffer condensation inside the unit may result.

Additional Sources for Reference

Maniatis T., E. F. Fritsch and J. Sambrook. *Molecular Cloning: A Laboratory Manual*, Cold Spring Harbor Laboratory, Cold Spring Harbor, NY.

Short Protocols in Molecular Biology, - A Compendium of Methods from Current Protocols in Molecular Biology, Edited by Fredrick M. Ausubel, et. al.

Adams, D., and R. Ogden, *Electrophoresis in Agarose and Acrylamide Gels, Methods in Enzymology*, Vol. 152 (1987) Academic Press, Inc.

Fotador, U.. *Simultaneous Use of Standard and Low-Melting Agarose for the Separation and Isolation of DNA by Electrophoresis*, *BioTechniques*, Vol. 10, No. 2, (1991)

Boots, S. *Gel Electrophoresis of DNA* ; *Analytical Chemistry*, Vol. 61, No. 8, April 15, 1989

Section 9 Optional Equipment

Buffer Exchange Port Option, D4-BP

The buffer exchange port option is used to recirculate the buffer during extended gel runs. Recirculation is used to prevent buffer depletion of certain low ionic running buffers, for extended runs multiple sample sets, or for RNA gels. If your unit has the buffer exchange port option, it will be fitted with two white buffer port terminals (Figure 12) and will contain two separate port inserts packaged in a small plastic bag located inside the unit upon arrival.

How these work...

The inserts are pushed into the attached ports on the side wall of the unit with the black O-ring side facing in. The insert will “snap” into place in the port in the “open” position and is ready to circulate buffer. Appropriate tubing is then connected to the small outer ringed ends of the ports for circulation using a separate recirculator or peristaltic pump. To close the port, which also releases the insert, simply press the flat metal button and the insert detaches. The port is now in the “closed” position.

Note. Buffer may also be passed through a heat exchanger. ▲

THERMO FISHER SCIENTIFIC OWL PRODUCTS WARRANTY USA

The Warranty Period starts two weeks from the date your equipment is shipped from our facility. This allows shipping time so the warranty will go into effect at approximately the same time your equipment is delivered. The warranty protection extends to any subsequent owner.

During the first thirty-six (36) months, component parts proven to be non-conforming in material or workmanship will be replaced at Thermo's expense, including labor. Installation, calibration and certification is not covered by this warranty agreement. The Technical Services Department must be contacted for warranty determination and direction prior to performance of any repairs. Expendable items, glass, filters and gaskets are excluded from this warranty.

Replacement or repair of component parts or equipment under this warranty shall not extend the warranty to either the equipment or to the component part beyond the original warranty period. The Technical Services Department must give prior approval for return of any component or equipment. At Thermo's option, all non-conforming parts must be returned to Thermo postage paid and replacement parts are shipped FOB destination.

THIS WARRANTY IS EXCLUSIVE AND IN LIEU OF ALL OTHER WARRANTIES, WHETHER WRITTEN, ORAL, OR IMPLIED. NO WARRANTIES OF MERCHANTABILITY OR FITNESS FOR A PARTICULAR PURPOSE SHALL APPLY.

Thermo shall not be liable for any indirect or consequential damages including, without limitation, damages to lost profits or loss of products.

Your local Thermo Sales Office is ready to help with comprehensive site preparation information before your equipment arrives. Printed instruction manuals carefully detail equipment installation, operation and preventive maintenance.

If equipment service is required, please call your Technical Services Department at 1-800-438-4851 (USA and Canada) or 1-740-373-4763. We're ready to answer your questions on equipment warranty, operation, maintenance, service, and special applications. Outside the USA, contract your local distributor for warranty information.



Rev. 0 9/12

THERMO FISHER SCIENTIFIC OWL PRODUCTS WARRANTY INTERNATIONAL

The Warranty Period starts two months from the date your equipment is shipped from our facility. This allows shipping time so the warranty will go into effect at approximately the same time your equipment is delivered. The warranty protection extends to any subsequent owner.

During the first thirty six (36) months, component parts proven to be non-conforming in material or workmanship will be replaced at Thermo's expense, excepting labor. Installation, calibration and certification is not covered by this warranty agreement. The Technical Services Department must be contacted for warranty determination and direction prior to performance of any repairs. Expendable items, glass, filters and gaskets are excluded from this warranty.

Replacement or repair of component parts or equipment under this warranty shall not extend the warranty to either the equipment or to the component part beyond the original warranty period. The Technical Services Department must give prior approval for return of any component or equipment. At Thermo's option, all non-conforming parts must be returned to Thermo postage paid and replacement parts are shipped FOB destination.

THIS WARRANTY IS EXCLUSIVE AND IN LIEU OF ALL OTHER WARRANTIES, WHETHER WRITTEN, ORAL, OR IMPLIED. NO WARRANTIES OF MERCHANTABILITY OR FITNESS FOR A PARTICULAR PURPOSE SHALL APPLY.
Thermo shall not be liable for any indirect or consequential damages including, without limitation, damages to lost profits or loss of products.

Your local Thermo Sales Office is ready to help with comprehensive site preparation information before your equipment arrives. Printed instruction manuals carefully detail equipment installation, operation and preventive maintenance.

If equipment service is required, please call your Technical Services Department at 1-800-438-4851 (USA or Canada) or 1-740-373-4763. We're ready to answer your questions on equipment warranty, operation, maintenance, service, and special applications. Outside the USA, contract your local distributor for warranty information.



Rev. 0 9/12

Thermo Fisher Scientific
401 Millcreek Road
Marietta, Ohio 45750
United States

www.thermofisher.com

ThermoFisher
S C I E N T I F I C