



USER MANUAL

Part 1 – all users

TOUCHCLAVE-LAB AUTOCLAVES



ADVANCED
STERILIZING
TECHNOLOGY

LTE Scientific Ltd
Greenbridge Lane, Greenfield, Oldham OL3 7EN, England
Tel: +44(0)1457 876221 Fax: +44(0)1457 870131
email: technical@lte-scientific.co.uk
www.lte-scientific.co.uk



FM 23948



0617

NOTICE

Copyright in this document is the property of LTE Scientific Limited ("LTE"). No part of this document may be copied, reproduced, or stored in a retrieval system without the prior written permission of LTE. The design rights in the products described in this document, including both hardware and software features, are the property of LTE.

Whilst all reasonable precautions have been taken to ensure the accuracy and relevance of this document, LTE does not accept liability for any errors or omissions, or for any damage or loss resulting from the use of the information contained herein.

LTE reserves the right to revise or replace any or all of the contents of this document without notice for any reason. Such reasons may include the need to reflect changes to the products or any of their features or attributes, or to revise the wording of this document.

Issue Date: 06 02 2012

CONTENTS

1. GENERAL	5
1.1 SCOPE OF USER MANUAL	5
1.2 CLASSIFICATION OF USER LEVELS	5
1.3 OVERVIEW OF TOUCHCLAVE LAB AUTOCLAVES	5
1.4 SAFETY PRECAUTIONS	6
2. MAIN FEATURES AND OPTIONS OF THE TOUCHCLAVE LAB RANGE	7
2.1 STANDARD FEATURES	7
2.2 OPTIONAL FEATURES	8
2.3 LOAD CAPACITIES	9
2.4 THE CYCLE SEQUENCE	10
2.5 TYPICAL CYCLES	11
3. THE CONTROL SYSTEM – COMMANDS AND SCREEN TYPES	12
3.1 COMMANDS	12
3.2 PROCESS SCREENS	12
3.3 MENUS	13
3.4 PASSWORD AND BATCH CODE SCREENS	13
3.5 PARAMETER SCREENS	15
3.6 WARNING AND CONFIRMATION SCREENS.	16
4. THE CONTROL SYSTEM - OPERATING THE DOOR	17
4.1 LOCKS	17
4.2 DOOR RESTRICTIONS	18
5. THE CONTROL SYSTEM – RUNNING A CYCLE	20
5.1 STARTING THE CYCLE	20
5.2 CYCLE IN PROGRESS	21
5.3 FAULTS	22
5.4 COOLING OVERRIDE	24
5.5 FINISHING A CYCLE	24
5.6 SAMPLE CYCLE PRINTOUT	25
6. THE CONTROL SYSTEM – OTHER FEATURES	26
6.1 MENU ACCESS TREE FOR SUPERVISORS AND OPERATORS	26
6.2 INITIAL ACCESS	27
6.3 DATA ARCHIVING	27
6.4 VIEW / PRINT LAST CYCLE	28
6.5 SET TIME/DATE	28
6.6 ALARMS	28
6.7 STATUS	28
6.8 CYCLE SETUP	29
6.9 USER SETUP	32
6.10 COOLING OVERRIDE	32
7. CARE AND MAINTENANCE	33
7.1 DOOR SEAL	33
7.2 FITTING A REPLACEMENT SEAL	34

7.3 CLEANING AND DRAINING THE CHAMBER	34
7.4 PRINTERS – INSTRUCTIONS FOR PAPER INSTALLATION	35
7.6 SPARE PARTS – CONSUMABLE	37

1. GENERAL

1.1 Scope of User Manual

This manual provides instructions in the use, set-up and maintenance for the Touchclave Lab autoclaves manufactured by LTE Scientific Ltd ("LTE").

All Touchclave Lab autoclaves have rectangular chambers with a choice of capacities – 150, 200, 300, 360 and 450 litres.

There is also a choice of steam supply to the chamber:

- Internal steam generator (KE models)
- Direct steam supply (KS models)
- In chamber heating (F models)

Autoclave users should be given training in the actual application environment. This manual is not intended as a substitute for such training.

1.2 Classification of User Levels

For safety and security, users of Touchclave-R autoclaves are classified in four User Levels:

- Operator
- Supervisor
- Maintenance Engineer
- Commissioning Engineer

The User Manual consists of three parts. Part 1 is intended for all User Levels. Part 2 and 3 are reserved for use by Maintenance and Commissioning Engineers, who have a higher User Level allowing them to perform certain functions which cannot be accessed by Operators and Supervisors.

1.3 Overview Of Touchclave Lab Autoclaves

Autoclaves are steam sterilizers which operate by injecting steam under pressure into the chamber or vessel where the load to be sterilized has been placed. Steam is generated by water heated either by an internal generator, customer steam supply or within the chamber. The temperature at which sterilization takes place is pre-programmed, the most common values being 121°C or 134°C, depending on the nature of load to be sterilized.

Control of the Touchclave-Lab autoclave is by means of a touch-screen on the front panel of the autoclave, using an intuitive hierarchical menu system. Different levels of access are built into the system by means of passwords indicating the User Level. The menus only display the options available at the User Level of the current user. Thus a user not trained and authorised for higher-level access cannot accidentally gain access to the more complex functions, such as cycle configuration.

During manufacture, the Touchclave-Lab control system will have been configured to run a standard range of cycles, which can be modified to suit your needs. Therefore the screen illustrations shown in this manual may not match exactly those displayed on your autoclave, although they will be similar.

1.4 Safety Precautions

Whilst the autoclave has built-in safety devices, their operation may be impaired if the autoclave is not used correctly and in accordance with the instructions. In addition, it is important to observe the following safety rules at all times:

- wait until the cycle is complete and the machine is cool before attempting to unload
- beware of residual steam in the chamber and hot surfaces when the door is opened at the end of a cycle
- wear an overall or lab coat, high temperature gloves and safety glasses to protect hands, arms and eyes when loading or unloading the chamber, since the load temperature may be as high as 100°C
- when moving the autoclave, for example during installation, remember that its weight can make it dangerous if not handled carefully
- ensure that the earth or ground of the power supply cable is connected to a suitable protective earth supply, and that the supply lines are correctly fused and isolated

2. MAIN FEATURES AND OPTIONS OF THE TOUCHCLAVE LAB RANGE

2.1 Standard Features

Touchclave KE Model – Internal Steam Generator

If your site does not have a built-in steam supply, the next option is the “Internal Low Pressure Generator”, which has a second pressure vessel integral to the machine, housing both the heaters and the water supply. The internal heaters generate the steam then the pressure in both the steam generator and the chamber rise until the set temperature is reached.

Only available on Non – Vacuum models without steam jacket

Touchclave KS Model – Direct Steam Supply

This model requires the customer’s site to have an accessible steam supply for connection to the autoclave. The advantages of this are that the machine has enhanced cycle times due to the high pressure of most sites’ supply, steam jackets are available and the machine(s) can be run from a smaller electric power supply.

Touchclave F Model – In Chamber Heating

The ‘F’ model has heaters positioned within the base of the chamber and generates the steam internally within the chamber.

Touchclave ‘F’ Autoclaves are modular in design, with the various optional features added to the original machine as required.

General

On KE and KS models the air removal stage is performed by a “Steam Purge” stage where steam and air are forced to the drain of the machine. After sterilization, cooling is achieved by pumping water around the outside of the chamber. Any drying is achieved using the residual heat of the chamber. All KE and KS models have water jacket cooling and condensate units fitted as standard and must have a mains water supply and drain available which are not demineralised and/or deionised.

2.2 Optional Features

There are four main optional performance-enhancing features than can be added to the machine to improve the speed of the cycle and the range of its functionality.

Constant Standby Generator

On KE models, as an alternative to the standard Internal Steam Generator , a high pressure Constant & Standby Steam Generator may be fitted. This option provides steam on demand and must be fitted if the autoclave is to have either steam jacket or vacuum and air ballast options installed. It reduces cycle time s and can support both positive and negative pulsing for air removal.

Constant Standby Generators have a high power rating so please ensure you have a sufficient supply available for the autoclave to use.

Steam Jacket

Fitting this option will improve the speed of your cycles. The steam jacket is used throughout the cycle to reduce the amount of condensation caused by a cool vessel wall. It speeds up recovery from negative pulses and provides heated insulation for the chamber. If used in conjunction with the Vacuum option, it also provides effective drying of the load at the end of cycle, expanding the functionality of the machine.

Category 3 Effluent Retention

This provides operator safety by filtering all non-condensable gases through a 0.2 micron filter prior to exhaust, whilst returning liquids to the chamber for sterilization. The HEPA filter is fitted inside a stainless steel housing that is accessible from the rear of the machine. The filter should be checked regularly to ensure performance and safety isn't impaired.

If Category 3 Effluent Retention is to be fitted, the machine must be hard-piped to a drain to allow the water remaining in the chamber at the end of the cycle to be forced down the drain.

Vacuum and Air Ballast

The Vacuum and Air Ballast option adds functionality to the start and end of the cycle, and expands the variety of loads that the machine can deal with. The vacuum can be used for air removal at the start of the cycle as a 'Pre-Vacuum' stage' , where a vacuum is drawn in the chamber to a set pressure. With Negative pulsing, steam is injected into the chamber to raise the pressure up to a set point, before the vacuum pump takes the pressure back down to the low set point again. This is repeated for a number of "pulses" until sufficient air has been removed from the load.

In the 'Post – vacuum' stage at the end of sterilizing the air ballast may be used to maintain a pressure in the chamber while it is being cooled rapidly. This prevents liquids from boiling over and sealed loads from rupturing. Then if required a vacuum is drawn in the chamber to dry the load.

If the Vacuum and Air Ballast option is to be fitted, a drain and mains water supply must be available.

Water Jacket

This feature is fitted as standard to KE and KS models and is available on option on 'F' models. The purpose of this feature is to speed up the cooling stage of the cycle

2.3 Load Capacities

Model	Steam Source	Capacity (Litres)	Chamber size HxWxD mm	Shelves / Positions	Overall size HxWxD mm	Weight Kg
TC150KE	Internal Generator	150	600x500x500	2/4	1815x720x1350	400
TC200KE	Internal Generator	200	600x500x660	2/4	1815x720x1500	480
TC300KE	Internal Generator	300	600x500x1000	2/4	1815x720x1500	650
TC360KE	Internal Generator	360	600x600x1000	2/4	1815x850x1500	700
TC 450KE	Internal Generator	450	600x600x1250	2/4	1815x850x1750	760

Model	Steam Source	Capacity (Litres)	Chamber size HxWxD mm	Shelves / Positions	Overall size HxWxD mm	Weight Kg
TC150KS	Direct Steam	150	600x500x500	2/4	1815x720x1350	360
TC200KS	Direct Steam	200	600x500x660	2/4	1815x720x1500	440
TC300KS	Direct Steam	300	600x500x1000	2/4	1815x720x1500	610
TC360KS	Direct Steam	360	600x600x1000	2/4	1815x850x1500	650
TC 450KS	Direct Steam	450	600x600x1250	2/4	1815x850x1750	710

Model	Steam Source	Capacity (Litres)	Chamber size HxWxD mm	Shelves / Positions	Overall size HxWxD mm	Weight Kg
TC150F	In Chamber	150	600x500x500	2/4	1815x720x1350	370
TC200F	In Chamber	200	600x500x660	2/4	1815x720x1500	450
TC300F	In Chamber	300	600x500x1000	2/4	1815x720x1500	620

2.4 The Cycle Sequence

The main stages of the Sterilising cycle are as follows:

Door Sealing

When the door has been closed you can either press "Lock" or select the cycle you wish to run and press start. This will cause the door to lock and seal automatically.

Air Removal

If your machine does not have the Vacuum and Air ballast option fitted, "Steam Purge" is the stage used for removing air from the chamber. With a Direct Steam or Constant Standby Generator equipped machine, a valve is opened and steam injected into the chamber. With a standard internal generator, the heaters are switched on and the steam generated as required. The steam is allowed to escape through a valve at the rear of the chamber, and in so doing carries out the air present in the chamber.

For loads that are more likely to trap air (e.g. plastic discard) then a Vacuum system is recommended. The stages of air removal in this case are "Pre-Vacuum" and "Negative Pulsing". The vacuum has superior air removal, but may increase the overall length of the cycle. This option is only available on machines fitted with a Constant Standby Generator.

Both Direct Steam and Constant Standby Generator equipped machines are also capable of positive pulsing. In this stage the pressure in the chamber is increased up to a high set point, usually 2000mBA (1 Bar on the gauge). The pressure is then allowed to escape through the vent valve of the machine, taking any air with it, until a low set point of 1200 mBar is achieved. This counts as 1 positive pulse, and the number of positive pulses can be set to any number required until sufficient air is concluded to have been removed from the chamber and load.

Heating up

The autoclave raises its pressure and temperature to the set sterilizing values specified for the cycle. The time taken by this stage depends on the level of the set points and the contents of the load to be sterilized. When the load probe (which should be placed either in the load to be sterilized or in a simulated load device) reports that the sterilizing temperature has been reached the stage will be complete.

Sterilizing

During this stage, the cycle achieves its objective. Whilst the sterilizing temperature can be set for any given cycle at any value between 105°C and 136°C, the values most commonly chosen are 121°C or 134°C, depending on the nature of load to be sterilized (see below). If the printer is fitted, its output during this stage will provide proof that the load has been sterilised. The length of time for sterilization can also be selected by the user, up to a maximum of 30 minutes.

Cooling

Once the sterilizing time is complete we enter the "Cooling" stage.

If Vacuum and Air Ballast is fitted then the machine can be configured to drop the pressure quite rapidly and pull the chamber down into a vacuum condition. This can only be done with certain loads – sealed bottles could explode and liquids boil over. So it is important you choose the correct cycle to run for the load you are sterilizing.

If a water jacket is fitted, it can either activate instantly or be configured to wait until the pressure in the chamber has dropped naturally before starting, in order to prevent the contents of the chamber losing pressure too rapidly.

Drying

Drying is more efficient with the Vacuum and Air Ballast option and an active steam jacket fitted to the machine. The pressure is dropped, where applicable, for a set amount of time so that the load can be vacuum dried as much as possible. With a steam jacket fitted, there is a significant reduction in moisture inside the vessel prior to the drying stage. As this stage relies on the residual heat inside the vessel to dry the load, there can be too much moisture present on the load for effective drying if there is no steam jacket fitted.

2.5 Typical Cycles

The table below shows details of some typical operating cycles, showing set values for different types of load.

OPERATING CYCLE NAME	CYCLE OR LOAD TYPE	STERILIZING TEMPERATURE	STERILIZING TIME	COOLING RATE
MEDIA	Fluid	121°C	15 minutes	40 minutes to 80°C
FLUID DISCARD	Fluid	134°C	5 minutes	40 minutes to 80°C
PLASTIC DISCARD	Plastic Discard	134°C	5 minutes	30 minutes to 80°C
EMPTY GLASSWARE	Empty Glassware	134°C	5 minutes	30 minutes to 80°C
MELT/FREE STEAM	Melt/Free Steam	105°C	30 minutes	20 minutes to 80°C
INSTRUMENT	Instruments	134°C	5 minutes	30 minutes to 80°C

The following test cycles are also available through the control system. They can only be carried out when there is no operating cycle in progress.

The LEAK TEST on vacuum models has two stages:

- Vac – a vacuum is pulled in the chamber
- Test – the chamber is sealed off.







Each stage is activated alternately by touching the **PUMP** button on the Leak Test screen of the control system. The test ends when the **FINISH** button is touched. The leak test logs time, pressures and temperature at the start and end of each stage, when requested by the operator using the **PRINT/LOG** button.

3. THE CONTROL SYSTEM – COMMANDS AND SCREEN TYPES

In this section, features and techniques for accessing the various capabilities of the Autoclave and information displayed about the autoclave's state are described.

3.1 Commands

The screens have been designed to have a common and consistent set of displays and commands. The standard buttons and their meanings are:

-  This button will appear on the top right of the screen. Return to Previous screen.
-  These Browse buttons will appear where there are multiple sets of screens to browse between.
-  These buttons move Up and Down menu options being displayed
-  This button is to select or Enter the currently highlighted option.
-  These buttons move back and forth between parameter values in a set.
-  These buttons select different options when a parameter value is a multiple-choice option.

3.2 Process screens

When the autoclave is in standby, the process screen displays information about the current temperatures and pressures and the currently selected cycle.



When the Autoclave is in cycle, the door control buttons and cycle control area is replaced by a cycle status display.

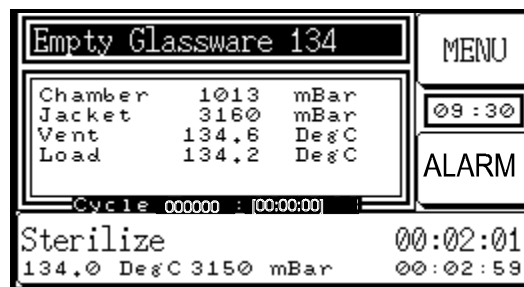





In the cycle status display, information about the current stage in progress within the cycle and the stage and cycle times is displayed.

3.3 Menus

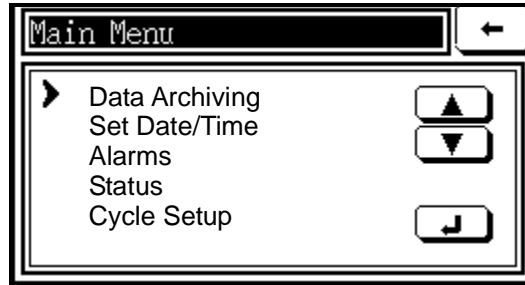
The Touchclave Lab system contains many different menus, which are described in detail later in this manual, however they all share a common format.

Examples:



The  and  buttons navigate the menu options. Once the arrow is on the desired option, touch the  button. A menu might have more than one page. Just move the arrow beyond the bottom of a page to change the page. Touching the  button to move back up the menu tree or to the current process screen.

3.4 Password and batch code screens

If a password is required for access to a menu or required to perform a certain operation, this screen will appear.

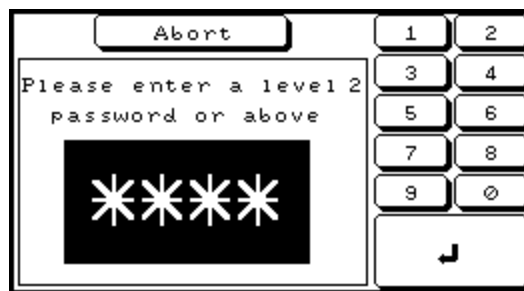

Enter a valid password using the numeric keypad and touch the Enter key . If an invalid password is entered a warning screen will be displayed.

If the cycle requires bar, batch or load codes, press the '**Codes**' button to display the following screen:

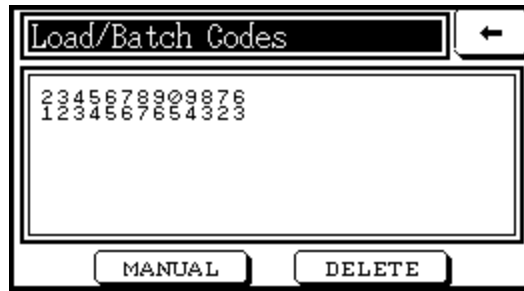

If a barcode scanner is attached, simply scan in the barcodes.

Touch the '**Delete**' button to delete the last code entered.

Press and hold the '**Delete**' button to delete all the codes.

If a barcode scanner is not attached or the barcode cannot be scanned, a code can be entered manually. To do this touch the '**Manual**' button to display the following screen:

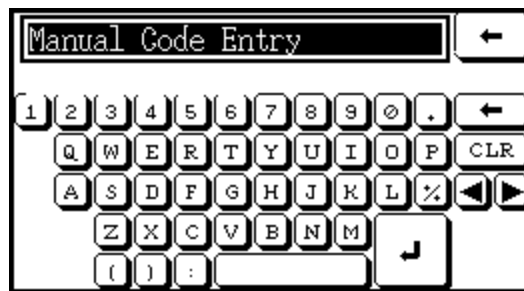

Touch the Enter button to confirm and go back to the previous screen.

Up to 32 Barcodes can be scanned at one time.



3.5 Parameter Screens

The Touchclave Lab system uses two types of parameter editing modes, Browse and Sequence.

The Browse mode has both the  and  buttons. These buttons move allow the user to navigate back and forth between each parameter in a set. The browse mode allows a user to select any of the parameters in a cycle.

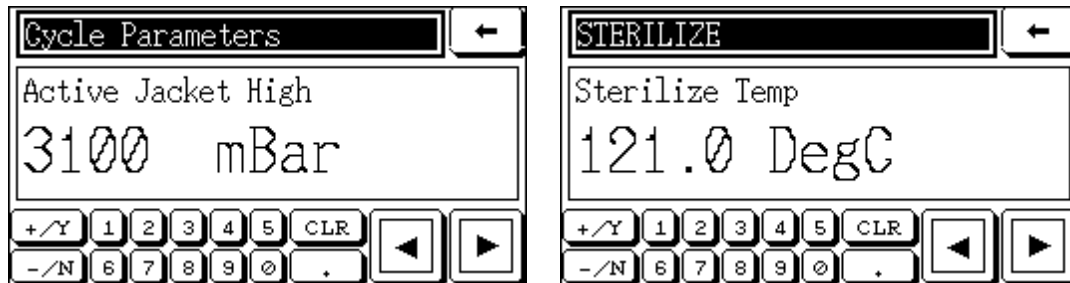
Examples:



The  and  buttons are used when the parameter is a multi-choice option. Browse through the possible options with these buttons.

Touch the  to leave the editing mode of that particular set of parameters.

The Sequence mode is used when a cycle is started which has variable parameters. The system asks for each parameter in turn. Touch the  button after each parameter has been entered. Once each parameter has been requested, the editing is complete and the cycle start sequence can continue.

Examples:



Touch the  in this case to abort the start sequence of the cycle.

3.6 Warning and confirmation screens.

Certain interface operations may respond with warning screens. These indicate the operation selected cannot be executed.

Example:



Touch the screen to cancel them and to take the system back to the previous screen.

Confirmation Screens

Certain actions may require that the operator confirm that they wish to proceed with the operation.

Examples:



Just touch either the **Yes** or **No** buttons.

4. THE CONTROL SYSTEM - OPERATING THE DOOR

Door operation is only possible when the Autoclave is out of cycle and no automatic start set. A process screen similar to this one will be visible if no restrictions apply and the door is unlocked.



Touching the '**Release**' button to allow the door to open.

4.1 Locks

Unlocking

Most Autoclave cycles are configured to automatically unlock door(s) during the Air Admission stage and once the cycle has been completed the door release button is displayed. If, however, a cycle is configured to leave the chamber locked at the end of cycle, the following screen is displayed, confirming that the door is locked and that there are no restrictions on opening the door.



The '**Unlock**' button starts the unlocking sequence and one of the following screens will appear whilst door unlocking is in progress:

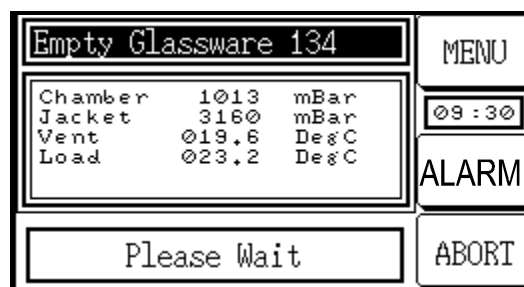

Touch the '**Abort**' button to stop the unlocking sequence.

Locking

Most cycles are also configured with a sealing stage at the beginning of cycle, which locks the door(s).

The machine may have been configured to show a '**Lock**' button when locking was possible. In this case, it will be necessary to lock the door before a cycle may be started. Touching the '**Lock**' button starts the locking sequence. During the door locking operation, a screen similar to this will appear:

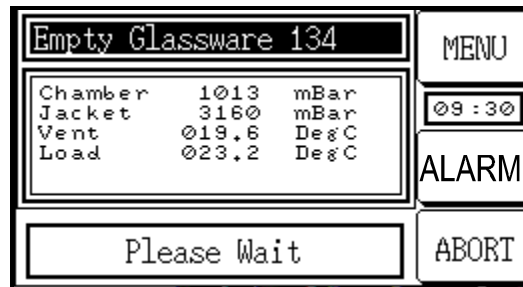

Touch '**Abort**' to stop the locking sequence.

4.2 Door Restrictions

When certain fault conditions or alarm conditions occur, the Touchclave Lab systems may restrict door control. The reasons for this and the associated screens are described below.

Discard Contamination

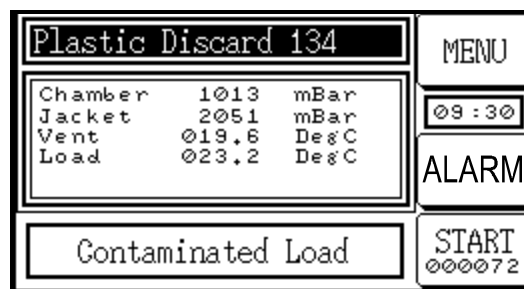

This screen will occur if the chamber is sealed because a discard cycle has failed and the chamber contains contaminated waste. The cycle must be run again and pass before door control is possible.

Chamber Pressure Low



If the chamber pressure is below the pre-set minimum for a cycle, then the door will be prevented from opening, even if the cycle has successfully completed sterilization.

Chamber Pressure High



If the chamber pressure is above the pre-set maximum for a cycle, then the door will be prevented from opening, even if the cycle has successfully completed sterilization.

Chamber Temperature High

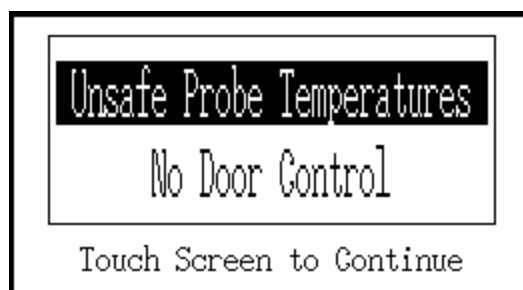

If the chamber temperature is above the pre-set maximum for a cycle, then the door will be prevented from opening, even if the cycle has successfully completed sterilization.

5. THE CONTROL SYSTEM – RUNNING A CYCLE

5.1 Starting the cycle

After the load has been placed in the chamber, the batch code entered (if required), and the door closed, the autoclave is ready to start a cycle. By touching the **START** button on the standby Process Screen (see section 4.2 above), a sequence of screens is activated to prepare the autoclave to start a cycle. The operator is first asked to nominate the type of cycle which is to be run. Some cycles may be set up to require a password to be entered. At the end of the sequence, a Cycle Start screen similar to the one below appears, allowing the operator to choose between an immediate start by touching the **START** button, or a delayed automatic start by touching the **AUTO** button.

If the cycle requires bar, batch or load codes then the following screen will appear, allowing a review of what codes have been entered. Nothing can be changed at this stage, as the door is closed:

Once the start sequence is complete a screen similar to the one below will appear:

Load/Batch Codes Review	
2345678909876	
1234567654323	
CONTINUE	

Cycle Start	
Cycle	Empty Glassware 134
User	A BODY
Cycle No	000072
Sterilize Time	180 Sec
Sterilize Temp	134.0 Deg C
Sterilize Pressure	315.0 mBar
Drying Time	300 Sec
START	
AUTO	

Manual Start

Touching the **Start** button on the 'Cycle Start' screen starts the cycle immediately.

Automatic Start

The automatic start feature allows a cycle to be started at some later time. This can be very useful for enabling a cycle to warm up the Autoclave before production Autoclaving starts or allowing a cycle to run overnight and cool down before unloading in the morning.

Touching the **Auto** button on the 'Cycle Start' screen displays the following screen:

Automatic Start	
Date	Today
+/Y 1 2 3 4 5 CLR	
- /N 6 7 8 9 0 .	
▶	

Automatic Start	
Time	06:00
+/Y 1 2 3 4 5 CLR	
- /N 6 7 8 9 0 .	
▶	

Touch the  key after entering each field of the date and time.

Once a new start time and date has been entered, touch the **'Continue'** button to put the system into auto-start mode when following process screen will be shown.



To leave the auto-start mode touch the **'Abort'** button. This operation requires a supervisor's password.

When the specified time arrives, the cycle will start provided that no alarms have been triggered during the waiting period.

5.2 Cycle in progress

Normal Operation

While the cycle is running a process screen like this one will be displayed:

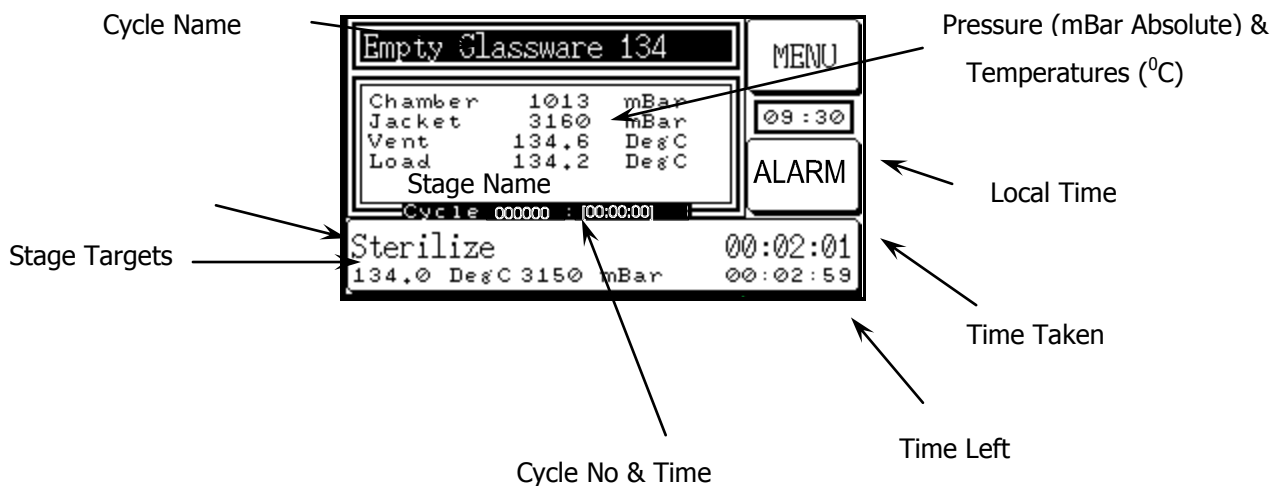

Manual Leak Test

During the 'Manual Leak Test' stage the following screen will be visible:

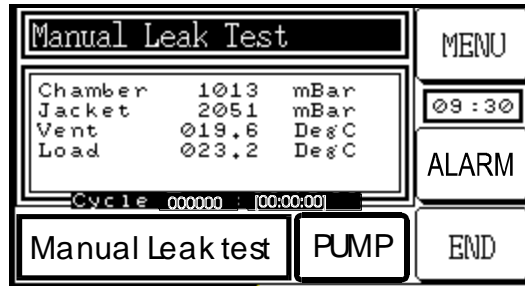

During this stage the operator can alternate between two sub-stages with the '**Pump On/Off**' Button.

- Vac – A Vacuum is pulled in the chamber
- Test – The chamber is totally sealed off.

The stage ends when the '**Finish**' Button is pressed.

The stage logs time, pressures and temperature at the start and end of these sub-stages and when manually requested by the '**Print Log**' button.

5.3 Faults

If an alarm condition occurs the control will signal on the display and a fail message will appear on the control screen. To see what the problem is and to clear the fault, press the alarm button on the display. You will then be taken directly to a menu like this, where the fault will be indicated in the list and the "Reset" button will clear the fault from the list once the alarm has been resolved. The "log" button will list all faults that have occurred whilst the machine has been powered on. Once the machine has been powered down however, the log will have been cleared.



Resetting of alarms is only possible out-of-cycle. Only a supervisor can clear alarms.

Faults In Non Discard Cycles

Any alarms that occur during a cycle are fatal to the operation of the cycle, as the integrity of the cycle has probably been compromised. All alarm conditions (other than engineering override) will cause the cycle to change to its pre-determined fault sequence of stages. The purpose of doing this is to abort the cycle in the safest possible way. All cycles during which an alarm condition has occurred will be marked as failed cycles.

Faults In Discard Cycles

If the load has not been through a complete sterilization stage in a discard cycle before it fails, it is assumed, for Health and Safety reasons, that there is contaminated discard in the chamber. In this case the Autoclave stops the current stage and jumps to the 'Discard Hold' stage, which uses the following process screen:

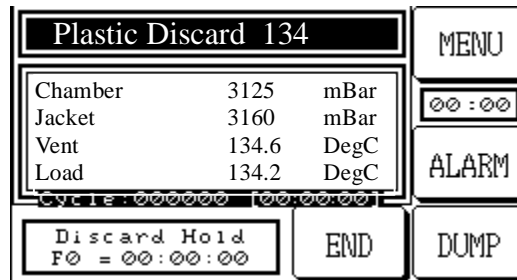

Selecting End

Choose this option if you feel the load has not been sterilised sufficiently. This will display the following screen:



Saying **Yes** to this confirmation will end the cycle immediately and move to the 'Failed' Screen. The chamber will remain sealed. Door Control will not be available and it will be impossible to select a different cycle. To clear this problem, run the discard cycle again. Once this has completed successfully, normal control will be available.

Selecting Dump

Choose this option if you believe the load to have been sterilised sufficiently and wish to be able to open the chamber. This will display the following screen.

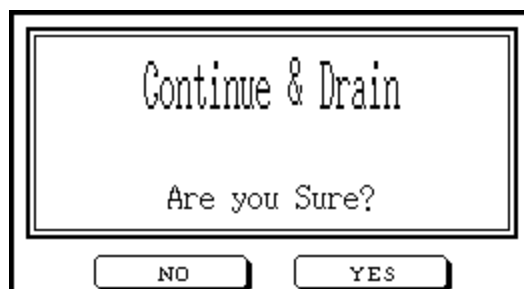

Saying Yes to this confirmation will require a Supervisor or above level password. If a valid password is entered, the cycle will go through the pre-determined fault stages of the cycle as if it was not a discard cycle, dumping the effluent down the drain and completing the cycle with door control available.

5.4 Cooling Override

It is possible to shorten the overall cycle time by accessing the Cooling Override through the menu, which can bring the cooling stage to an end after the temperature has reduced to below 100°C (rather than the normal 80°C). If the Cooling Override is used, care must be taken to ensure that the temperature inside the chamber is safe for the load when it is suddenly exposed to ambient air temperature. It is recommended that the user draws up a procedure for use of the Cooling Override function, and that its availability is limited to supervisors.

5.5 Finishing a Cycle

At the end of the cycle the autoclave will show either 'Pass' or 'Fail' screen.

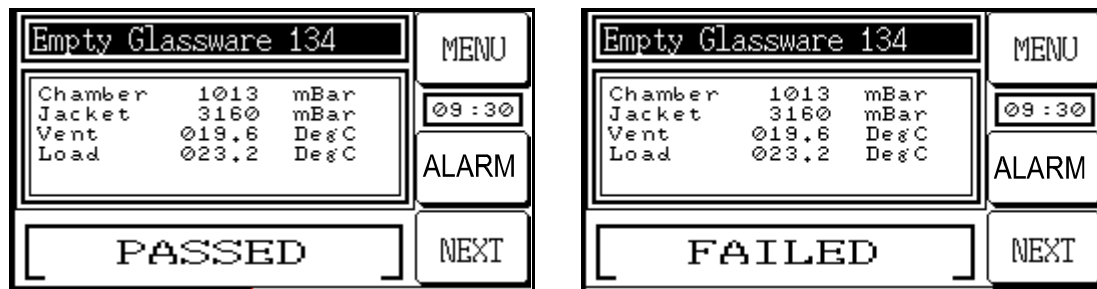

If Cooling Override has been used the text '**Cooling Override Used**' will flash below the result.

If the cycle has passed and cooling override has not been used, touch the continue button to go straight to door control.

If the cycle has failed or cooling override has been used, touch the '**Continue**' to be prompted for a supervisor or above level password. Upon entering a valid password, door control should be available and the errors will be cleared unless they are still valid.

If Cooling Override was used, it is the user's responsibility to ensure that the current temperature inside the chamber is safe for the load within when rapidly exposed to ambient air. If any doubt exists, then local procedures for this situation should be observed or a supervisor's assistance should be sought before proceeding.

5.6 Sample cycle printout

The following is a sample of a printout for all cycles except the leak test

```
C/NAME
J8987
AESTREL 1

Report :- Cycle
Program :- ENFT1 GLASSWARE
Operator :- N/A
Cycle No :- 000019
Prog No :- 03
Date :- 25/05/07
Start Time:- 11:23
Steri Temp:- 136.0 oC
Steri Time:- 00:15:00

Time   Chem Vent Load
H:M:S   mBar  oC   oC

DOOR SEALING
00:00:00 1028 021 3 028 2
00:00:05 1028 021 4 028 2
STEAM PURGE
00:00:05 1028 021 4 028 2
00:18:00 1436 108 0 103 9
HEATUP
00:18:05 1438 108 0 103 9
00:34:33 3263 137 7 136 0
STABILISATION
00:34:33 3263 137 7 136 0
00:35:32 3261 137 5 136 2
STERILIZATION
00:35:32 3261 137 5 136 2
00:36:32 3218 137 3 136 4
00:37:32 3252 137 5 136 5
00:38:32 3244 137 6 136 6
00:39:32 3264 137 6 136 7
00:40:32 3261 137 7 136 8
00:41:32 3226 137 4 136 9
00:42:32 3256 137 6 136 9
00:43:32 3225 137 4 136 9
00:44:32 3265 137 7 136 9
00:45:32 3234 137 4 137 0
00:46:32 3238 137 4 137 0
00:47:32 3282 137 7 137 0
00:48:32 3224 137 4 137 1
00:49:32 3263 137 6 137 0
00:50:32 3227 137 5 137 0
00:50:32 3227 137 5 137 0
COOLING
00:50:32 3227 137 5 137 0
01:28:14 1023 043 4 080 0
AIR ADMISSION
01:28:14 1023 043 4 080 0
01:28:43 1021 043 0 079 7

Vent Above Sterilize Temp :- 00:27:25
Load Above Sterilize Temp :- 00:17:25
FC Achieved :- 14:22:25

Cycle No :- 000019
Errors :- No
Warnings :- No
Result :- Passed
Cycle Time:- 01:28:43
Approved :- N/A

Cycle Complete

Operator :- _____

LTE SCIENTIFIC
GREENIDGE LANE
GREEN-FIELD
OLDFHAM
LTE SERVICE CALL
Tel:01457-876221
```

6. THE CONTROL SYSTEM – OTHER FEATURES

6.1 Menu access tree for supervisors and operators

Access to the menu at Operator Level is limited to locking and unlocking the door, selecting a cycle to run, starting a cycle, and viewing alarms.

A person with Supervisor Level or higher status has wider access to the main menu. The access tree is set out below. Highlighted areas are only present in the menu if the applicable option has been fitted to the autoclave. The main functions are described later in this section.

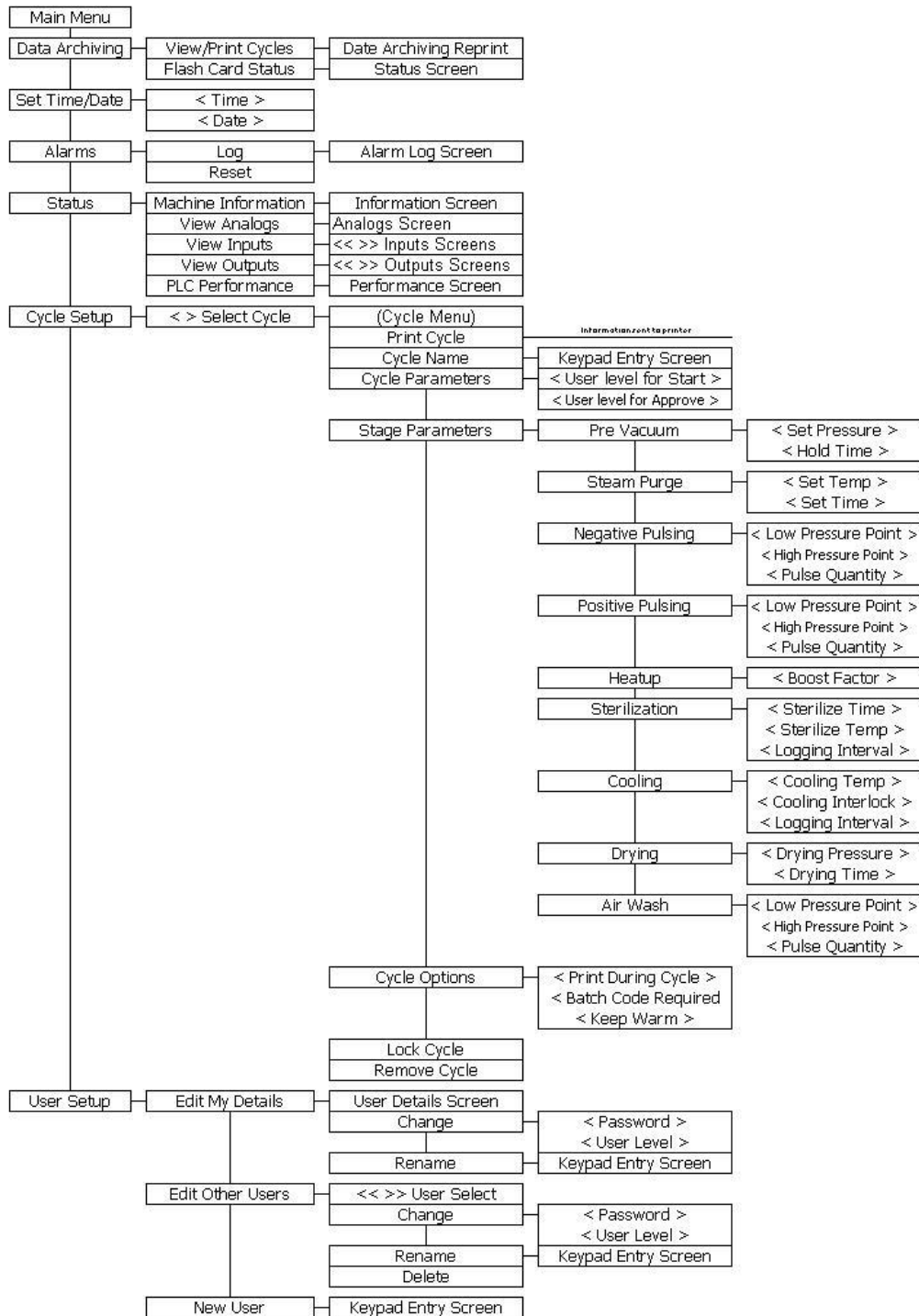

6.2 Initial access

Access to the main menu is not required for operating the autoclave and is normally limited to a person with supervisor or higher status. Touching the **MENU** button on the Process Screen leads to the Password Screen to gain access to the main menu. Depending on the authorisation allowed by the password and the current operating mode of the autoclave, a range of functions will appear on the 'main menu' screen. A typical menu screen is shown below.

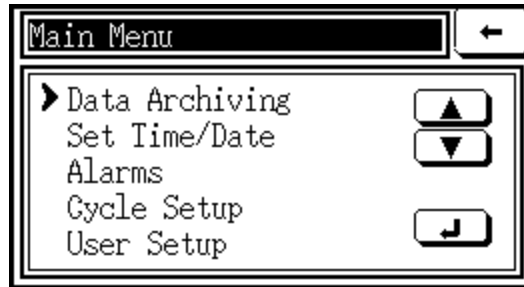

The main functions accessible through the menu are described in more detail below.

6.3 Data Archiving

If the system includes the Data Archiving option, it can be accessed when there is no cycle running. Data Archiving, which allows detailed cycle records to be kept, is useful for reference purposes, and may help the user to determine the best cycle for a given load. When Data Archiving is accessed on the main menu by touching the \leftarrow command, the following screen will appear:

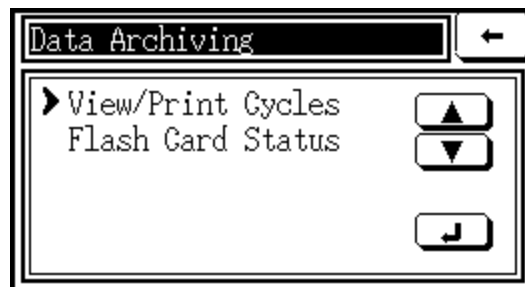

Data archiving allows a detailed cycle record to be maintained for the Autoclave. This is useful for reference and cross reference purposes as well as helping you; the user to determine the best cycles for given loads.

View/Print Cycles When this function is selected, the user can browse rapidly between the cycles recorded in the archiving system using the \ll and \gg buttons. When a cycle is selected, its details appear on the screen and the data in the archive will be verified. When the screen shows 'Report OK', as shown in the example below on the left, the **VIEW** button will display the data on the screen and the **PRINT** button will print it if a printer is fitted to the autoclave.

Flash Card Status When this function is selected, the status of the Data Archiving system will be displayed as on the screen below on the right. If remote archiving is available, the value for 'Awaiting Transfer' will normally be close to zero, unless there is a transfer communication problem. The value for 'Free Space' shows how close the card is to needing to be replaced.



6.4 View / Print Last Cycle

If the system does not include the Data Archiving option, this function will appear in the menu when there is no cycle running. It is useful for fault finding or replacement of a printout. It is important to remember that, when a new cycle is started, the 'last cycle' information is permanently deleted from the system's memory.

6.5 Set Time/Date

Selection of this function allows the system clock to be set using the screens. The browse buttons are used to move between the date and time screens.



6.6 Alarms

This function calls up the Alarm List screen (illustrated in the preceding section). The Reset button is only used when no cycle is running.

6.7 Status

By selecting Status, a list of the following information display screens appears.

Machine Information Displays the type and version of the autoclave, and its software version.

View Analogs Displays the analog inputs to the control system – vent, load, keep warm (if fitted), temperature channels, jacket pressure (if fitted), chamber pressure. The raw data are displayed by signal direct from the sensor, together with the calibration-adjusted figures.

View Inputs Shows the condition of key inputs required to run a cycle, such as water level or door status, as monitored by the sensors and switches of the system.

View Outputs Shows the condition of various outputs whilst running a cycle, such as valves or pumps, in order to assist with identifying faults or problems.

Sterilization Information Displays the F0 value (a measure of sterilization) for the last cycle. This information can be useful for improving cycle times.

6.8 Cycle Setup

When an 'empty slot' is selected within the Cycle Setup menu, the following sub-menu is displayed.

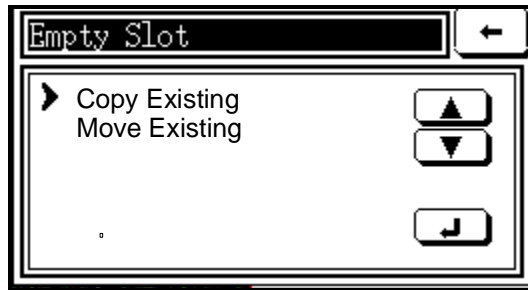

By selecting **Copy Existing**, an existing cycle can be duplicated in the Empty Slot or, by choosing **Move Existing**, an existing cycle can be moved from its original slot to the Empty Slot.

When an existing cycle is selected within the Cycle Setup menu (as in the screen below on the left), a sub-menu appears for that cycle (as in the screen below on the right).

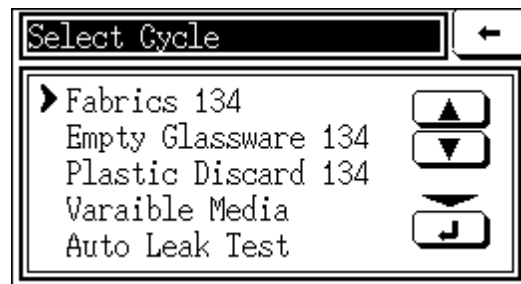
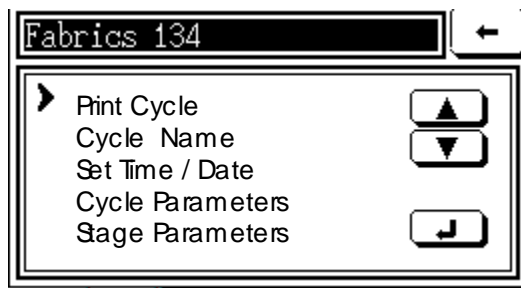

The following functions can be selected from the cycle sub-menu.

Print Cycle Prints full details of the cycle and its parameters at each stage.

Cycle Name Allows a cycle to be named or re-named.

Cycle Parameters Allows a user level to be specified to start a cycle, or to approve a cycle if it is recorded as 'failed'; also used to specify whether printouts, batch codes, or 'keep warm' facility (if fitted) are required.

Stage Parameters Allows the supervisor to set the variable parameters for each stage of the cycle. The stages and parameters available for setting are as follows:

Steam Purge – *Set Temperature; Set Time*

For non-vacuum machines, air is removed from the chamber during this stage. Steam is generated in the chamber and escapes through a valve, carrying air out of the chamber with it. If the load is likely to contain air pockets, the time may be extended to remove as much air as possible.

Pre-Vacuum (if vacuum fitted) – *Set Pressure; Hold Time*

The set temperature determines the pressure to which the vessel is drawn down (for example, 500mBar), in order to begin removing air before sterilization. When this pressure is reached, the Hold Time determines the time in seconds for which the pressure is to be held.

Negative Pulsing (if vacuum fitted) – *Low & High Pressure Points; Pulse Quantity*

Vacuum systems have superior air removal, but may increase the length of the cycle. Low and high pressure limits are normally set at around 500mBar and 800mBar respectively. The air is removed during a set quantity of pulses.

Positive Pulsing – *Low & High Pressure Points; Pulse Quantity*

Both direct steam and constant standby generator equipped machines are also capable of positive pulsing. In this stage the pressure in the chamber is increased up to a high set point, usually 2000mBar (1 Bar on the gauge). The pressure is then allowed to escape through the vent valve of the machine taking any remaining air with it, until a low set point of 1100 - 1200 mBar is achieved. This counts as 1 positive pulse, and the number of positive pulses can be set to any number required until sufficient air is concluded to have been removed from the chamber and load.

Heat up – *Boost Factor*

The controlling temperature of the autoclave can be set at a specified temperature over the set sterilizing temperature, until the load reaches the set sterilizing temperature. This procedure can reduce overall cycle time, with the risk of overshooting the upper controlling temperature, so it may be suitable for discard loads but not media loads. The setting range is from zero to 250mb/2.5°C.

Sterilization – *Sterilize Time; Sterilize Temperature; Logging Interval*

The purpose of the autoclave is to sterilize the load effectively, and the appropriate Sterilize Time (measured in seconds) will depend on the type of load. Sterilize Temperature also depends on the type of load, and for most loads is between 115°C and 136°C. The Logging Interval, also measured seconds, determines how often the cycle details are recorded or printed during this stage.

Cooling – *Cooling Type; Cooling Temperature; Cooling Interlock; Logging Interval*

'Cooling type' offers a choice of:

- a. normal cooling, which relies on fan cooling while the steam pressure slowly drops to atmospheric pressure; or
- b. dynamic cooling, which uses fan cooling until the pressure has dropped to 1150mba, when air is blown through the chamber to reduce cooling time and assist in drying the load; or
- c. ballast cooling, which maintains pressure in the chamber while replacing the steam with air, thus avoiding loss of fluids, particularly for media loads.

'Cooling temperature' sets the temperature to which the load must reduce before it is safe to open the door. To ensure the setting operates safely, the load probe must be within either the load or a simulated load.

'Cooling Interlock' is an optional safety measure which is best suited to liquid loads. When the temperature is set, the cooling cycle is prevented from ending until the temperature of both the load and the chamber have reduced to the set level. This setting requires a separate probe to monitor the chamber temperature.

'Logging Interval' determines how often the cycle details are recorded or printed during this stage.

Drying – *Drying pressure, Drying time*

Only where the system has a vacuum system fitted can a low Drying Pressure be set, whereby any liquid in the chamber will flash to steam at a significantly lower temperature than 100degC.

Without the vacuum option, drying relies solely on the residual heat inside the vessel to dry the load. Pressure is set low e.g. 500mBar where available, and time is set in seconds at the supervisor's discretion.

Air Wash – *Low pressure point, High pressure point, Pulse quantity*

Air is allowed in to the chamber through the Air Break valve and drawn out by the vacuum pump to create a flow of air over the load. This removes steam from the chamber and improves the effectiveness of the drying cycle.

Lock Cycle Enables the cycle to be locked or unlocked. A locked cycle cannot be used.

Remove Cycle Allows the cycle to be removed from the menu, thereby creating an Empty Slot.

6.9 User Setup

This function is used to nominate users of the autoclave, using the menu screen below.



Edit My Details

By selecting this function, the screen displays User Name, together with the Level (for allowing access to certain parts of the control system) and Password of the User. Touching the **CHANGE** button allows a User who is currently logged on to the system to change the Password, but not the Level. Touching the **RENAME** button allows the User to be re-named.

Edit Other Users

This function displays details of Users who have a lower Level than the User who is currently logged on to the system. Touching the **CHANGE** button allows the current User to change the Password and Level of a lower-level User, provided that the new Level is no higher than that of the current User. Touching the **RENAME** button allows the current User to re-name a lower-level User. Touching the **DELETE** button allows the current User to remove a lower-level User.

New User

When a new User's name is entered using the keypad, the system will display the 'Edit Other Users' screen to allow the new User's details to be entered.

6.10 Cooling Override

This function is only available during the cooling stage of the cycle, after a pre-set minimum cooling time has elapsed. Only Users at supervisor Level may use it. When selected, the following screen appears, with a warning message:



By touching the **YES** button, the autoclave will move to the next stage in the cycle. When the cycle has finished, the User will be warned that this function was used and will not be permitted to move on to door control until the User's password has been entered. Door control will continue to be restricted until the temperature is below the temperatures specified in the cycle parameters.

7. CARE AND MAINTENANCE

Touchclave Lab autoclaves are designed to be easy to maintain. Simple preventive maintenance, as described in this section, will assist in achieving this objective, whilst prolonging the life and reliability of the autoclave.

7.1 Door Seal

Touchclave Lab autoclaves use a "floating seal" system. The seal sits in a groove on the front of the chamber. When the door is shut and locked, air is then applied behind the seal to ensure full sealing. If the seal has been damaged, it will not be able to seal fully, in which case the autoclave should not be run. If a cycle is run with a damaged door seal, there is a risk that steam will escape from the chamber, causing damage to the equipment or injury to the operator.

Therefore the seal should be checked frequently for any damage and, if necessary, replaced. The seal and the door face should be cleaned at frequent intervals, and certainly not less than once a month, to ensure the efficiency of the seal and to prolong its useful life.

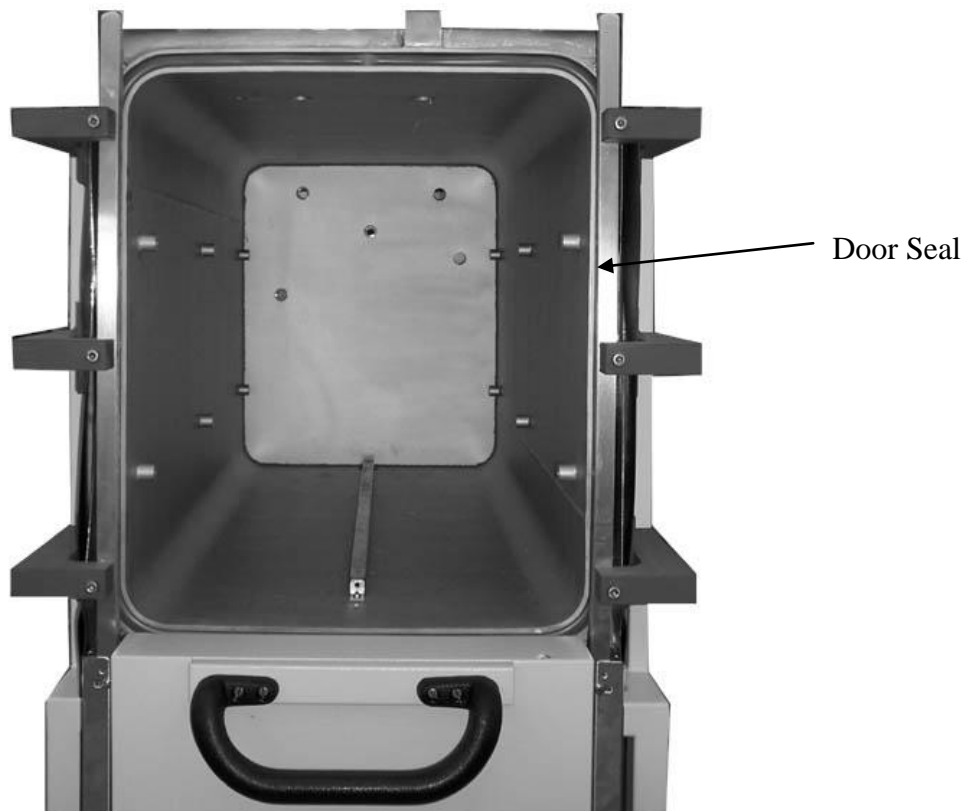

7.2 Fitting a replacement seal

Seals should only be replaced by trained supervisors or engineers. When the old seal has been removed, the new seal is pressed into the circular groove. Pressure should first be applied to the seal at the top of the chamber opening, and then at the bottom, whilst ensuring that both sides of the seal are equidistant from the centre of the chamber. Then the two sides of the seal should be pressed into the groove, whilst ensuring that the all parts of the seal are equidistant from the centre of the chamber. Finally any excess seal should be pressed firmly in to the groove.

Any attempt to fit the seal in one movement, or to stretch the seal, may result in a poor fit and should be avoided. A poorly fitted seal can result in a malfunction when the door has been closed.

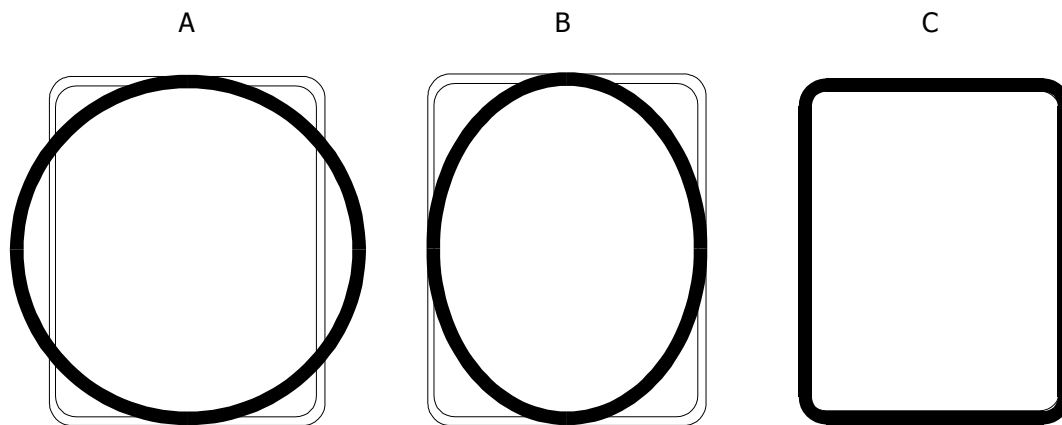

Press the top of the seal into the seal groove, and then press the bottom of the seal into the groove, ensuring that there are equal amounts of excess seal at each of the two sides (A).

Press the left and the right hand sides into the groove, ensuring that there are equal amounts of excess seal at each of the four corners (B).

Fit the remaining excess seal into the groove by starting in the centre of the excess sections at the four corners, and then working outwards (C).

7.3 Cleaning and draining the chamber

In chamber heating 'F' models chamber draining requires the use of the 'Engineering' area of the control system and therefore should only be carried out by a competent engineer with a high level access code.

KE and KS models do not require chamber draining as water is not held in the vessel. The internal generator will require maintenance periodically in order to de scale the vessel but this again is an engineering function and not covered by this manual

7.4 Printers – instructions for paper installation

Porti P40 Printer

Note: It is important to use paper rolls that meet the specifications. Do not use paper rolls that have the paper glued to the core because the printer cannot detect the paper end correctly.

1. Make sure that the printer is not receiving data; otherwise data may be lost.
2. Open the paper roll cover by applying your fingers on both sides of the printer, push up when the lock is released as shown in the drawing below.

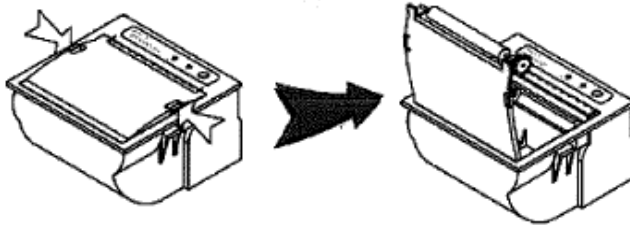

3. Remove the used paper roll core if there is one.
4. Insert the paper roll as shown below.

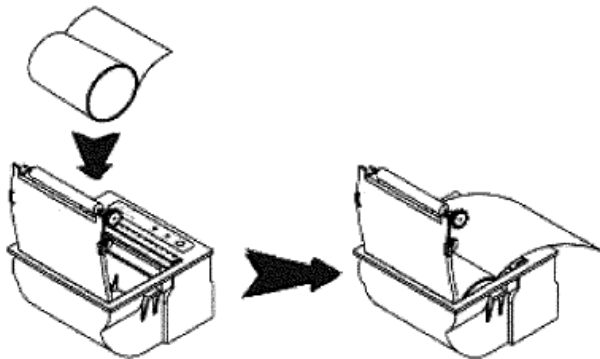

5. Be sure to note the correct direction that the paper comes off the roll.

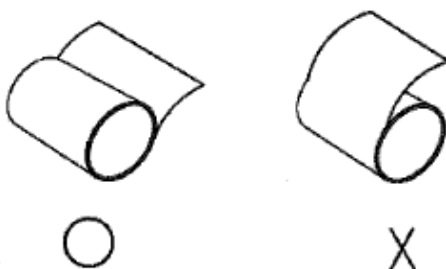

6. Pull out a small amount of paper and then close the cover as shown.
7. Tear off the paper.

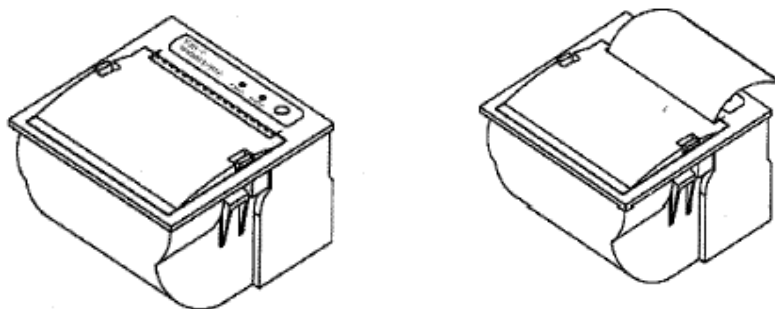

CBM 920 Printer

1. Open the front cover by pushing the 'Knob' to the right and pull forward.

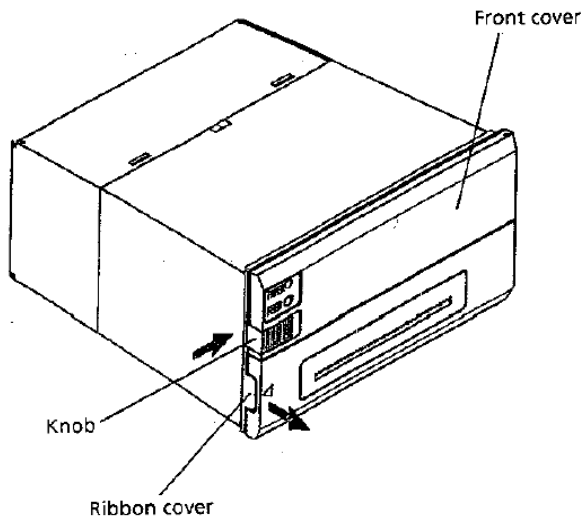

2. Cut the edge of the paper as per the following drawing.

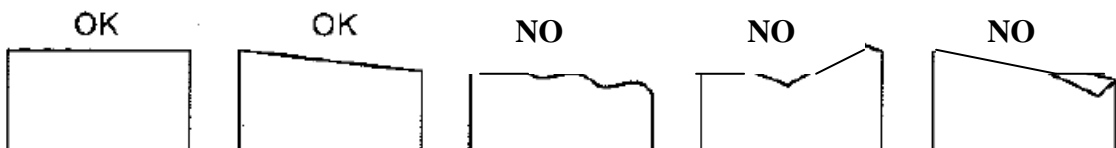

3. Insert the paper into the printer paper insertion slot in the printer mechanism.
If auto loading is selected the paper will load automatically, if not, push the LF switch until the paper enters the printer mechanism.
4. By holding the paper holder in the arrowed direction, insert the paper roll by holding the paper core.
5. Eliminate the 'slack' on the paper and close the front panel.

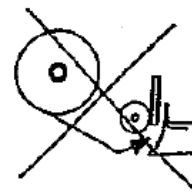
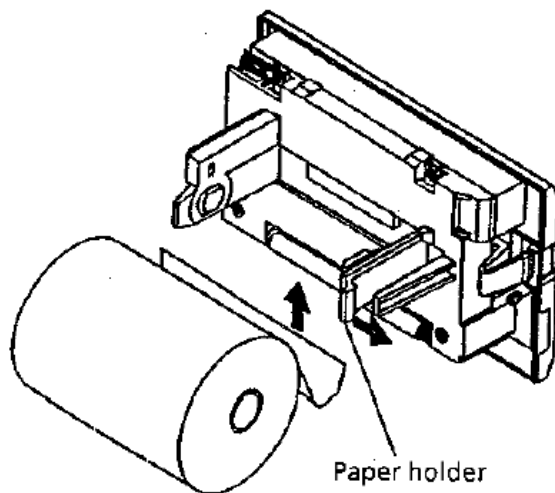

7.6 Spare parts – consumable

The table below lists the main parts which will need to be replaced from time to time. They can all be ordered from the manufacturer, LTE Scientific Ltd., or from an authorized distributor. It is advisable to keep a stock of such parts in order to avoid interruptions in the operation of the autoclave.

Part no.	Quantity	Description	Availability
710211	1	Air Inlet Filter	Ex stock
1100166/A	1	Door Seal	Ex stock
1100344	1	Door seal 360/450	Ex stock
251474PK	5 (Pack)	Porti P Printer Roll	Ex stock
251598	1	Citizen CBM 920 Printer Roll	Ex stock
251597	1	Citizen CBM 920 Printer Ribbon	Ex stock