

Top Loading Balances

User Manual

European Catalogue Numbers:

VWRI611-2258	VWRI611-3395	VWRI611-3327	VWRI611-3478	VWRI611-2565
VWRI611-3328	VWRI611-2273	VWRI611-2288	VWRI611-2610	VWRI611-3397
VWR611-2259	VWRI611-3391	VWRI611-3378	VWRI611-3367	VWRI611-3361
VWR611-3122	VWRI611-3459	VWRI611-3471	VWRI611-2296	VWRI611-2309
VWR611-2260	VWRI611-2274	VWRI611-3469	VWRI611-3346	VWRI611-3388
VWR611-3123	VWRI611-3371	VWRI611-2289	VWRI611-3545	VWRI611-2320
VWR611-2261	VWRI611-3269	VWRI611-3277	VWRI611-2298	VWRI611-3375
VWRI611-3343	VWRI611-2275	VWRI611-3348	VWRI611-3379	VWRI611-2321
VWR611-3261	VWRI611-3373	VWRI611-3472	VWRI611-2299	VWRI611-3383
VWRI611-2262	VWRI611-3270	VWRI611-3296	VWRI611-3370	
VWRI611-3386	VWRI611-3458	VWRI611-2292	VWRI611-2300	
VWRI611-3262	VWRI611-2276	VWRI611-3384	VWRI611-3374	
VWR611-2263	VWRI611-3392	VWRI611-3543	VWRI611-2301	
VWRI611-3546	VWRI611-2277	VWRI611-2600	VWR611-3360	
VWR611-3263	VWRI611-3396	VWRI611-3355	VWRI611-2319	
VWRI611-3326	VWRI611-2278	VWRI611-2548	VWRI611-3359	
VWR611-2264	VWRI611-3298	VWRI611-3464	VWRI611-3480	
VWRI611-3351	VWRI611-3271	VWRI611-2293	VWRI611-2629	
VWR611-3264	VWRI611-2279	VWRI611-3353	VWRI611-3398	
VWR611-2265	VWRI611-3354	VWRI611-3544	VWRI611-2302	
VWRI611-3350	VWRI611-3272	VWRI611-3466	VWRI611-3347	
VWRI611-2272	VWRI611-3283	VWRI611-3462	VWRI611-2565	

Version 1 Issued 14/04/15

Soft. R_6.02



Legal Address of Manufacturer

Europa
VWR International bvba
Researchpark Haasrode 2020
Geldenaaksebaan 464
B-3001 Leuven
+ 32 16 385011
<http://be.vwr.com>

Country of origin

Italy

Intended use

Precision balances are used for accurate weighings in laboratory, industry, universities, etc...

INDEX

1	INSTALLATION INSTRUCTION	3
2	STORAGE	4
3	WEIGHING PAN ASSEMBLY	5
4	KEYBOARD AND DISPLAY	6
5	OVERVIEW	7
5.1	FRONT PART OF THE BALANCE.....	7
5.2	REAR AND BOTTOM PART OF THE BALANCE.....	8
5.3	REAR AND BOTTOM PART OF THE BALANCE, MODELS VERSION SQUARE PAN.....	9
5.4	IONISER (ONLY FOR MODELS -ION).....	10
6	WEIGHING	12
6.1	STAND BY.....	12
6.2	SIMPLE WEIGHING.....	12
7	CALIBRATION	13
7.1	EXTERNAL CALIBRATION.....	13
7.2	INTERNAL CALIBRATION.....	14
7.2.1	<i>Autocalibration (AUT-CAL)</i>	15
7.2.2	<i>Internal calibration (I-CAL) [locked for verified balances]</i>	16
7.2.3	<i>External calibration (E-CAL) [locked for verified balances]</i>	16
7.2.4	<i>Technical calibration (TEC-CAL) [locked for verified balances]</i>	17
7.3	VERIFICATION.....	18
8	TARE FUNCTION	19
8.1	MANUAL TARE FUNCTION.....	20
8.2	OPTIONAL ALPHANUMERIC EXTERNAL KEYBOARD.....	21
9	WEIGHT UNITS	23
10	PC COMMUNICATION SETTING	26
11	PRINTER SERIAL COMMUNICATION SELECTION	27
12	TRANSMISSION SPEED SELECTION	28
13	AUTOZERO FUNCTION	29
14	FILTERS SELECTION	30
15	STABILITY FUNCTION	31
16	DISPLAY CONTRAST REGULATION	32
17	DISPLAY BACKLIGHT SETUP	33
18	AUTO POWER-OFF FUNCTION	34
19	SELECTION OF WORKING MODE WITH TABLET	35
20	PIECECOUNTING FUNCTION	37
20.1	VISUALIZATION OF TOTAL AND UNIT WEIGHT OF PIECES.....	38
20.2	MANUAL INSERTION OF THE UNIT AVERAGE WEIGHT.....	39
20.3	AUTOMATIC UPDATE OF UNIT WEIGHT.....	40

21	DENSITY DETERMINATION OF A SOLID OR A LIQUID	41
21.1	DENSITY DETERMINATION OF A SOLID	41
21.2	DENSITY DETERMINATION OF A LIQUID	43
22	MAXIMUM LOAD DETERMINATION FUNCTION	45
23	PERCENTAGE WEIGHING FUNCTION	46
23.1	MODE WITH WEIGHT REFERENCE.....	46
23.2	MODE WITH MANUAL INSERTION OF THE REFERENCE WEIGHT.....	47
24	ANIMAL WEIGHING FUNCTION	49
25	TOTALIZING	50
26	THRESHOLD FUNCTION.....	52
26.1	BOTH THRESHOLDS SET	53
26.2	LOWER THRESHOLD SET ONLY	53
26.3	HIGHER THRESHOLD SET ONLY	53
27	RS232 INTERFACE FEATURES.....	54
28	ERROR CODES.....	60
29	MAINTENANCE AND CARE	61
30	QUICK GUIDE TO BALANCE PARAMETERS SETUP.....	62
31	QUICK GUIDE TO THE USE OF THE BALANCE PROGRAMS.....	63
32	BALANCE TECHNICAL FEATURES.....	64
33	OPTIONAL ACCESSORIES.....	65
34	TECHNICAL SERVICE	65
35	WARRANTY.....	66
36	COMPLIANCE WITH LOCAL LAWS AND REGULATIONS.....	66
37	EQUIPMENT DISPOSAL.....	66

1 Installation instruction



WARNING:

Please follow carefully these steps for installing and use the new balance before starting your work routine. A way of use of the instrument different from this user manual will not guarantee the instrument's safety anymore.

- **Remove** the balance, calibration weight(if included) and accessories from the carton and check for any visible damage of the instrument.



ATTENTION

In models with internal calibration remove the screw in the left lower part of the balance (see par.5)

- **Do not install** the balance in a place with air flows, heavy thermal changes and vibrations.
- **Do not use** the balance in blast risk environment.
- **The humidity rate** of the balance environment must be between 45% and 75%

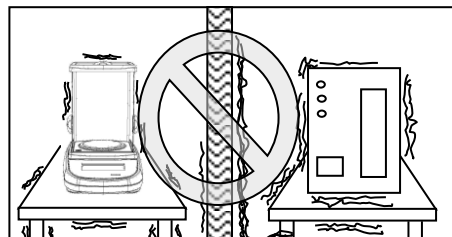
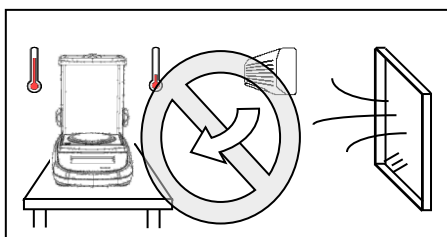

- **Place** the weighing pan and the support pan on the balance (see par. 3).
- **Level** the balance using the level bubble and levelling feet located underneath the case

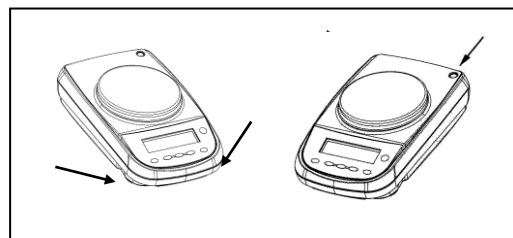
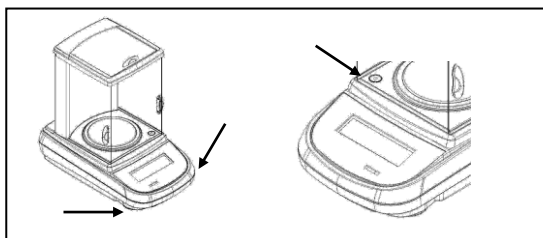

- **Connect** power supply to connector 2 located on the rear panel of the unit (see par. 5).

- **Insert** power unit into AC outlet, **which shall be easily accessible**; after few seconds the balance will automatically switch on.
- **Balance Warm-up:**
 - Wait 8 hours from switch one for Analytical balances (0,0001g)
 - Wait 30 minutes for other models

Then calibrate the balance using the appropriate mass (if supplied), following instructions (par.7).

It is strongly suggested not to disconnect the balance from the electrical mains and to use the ON/OFF button to stand-by the balance when you finished using it

- **Calibrate** again the balance every time it's moved to another place
- **Check** balance calibration periodically.
- **We recommend** not dropping heavy objects on balance pan, in order to avoid damages.
- **Assistance service** must be effected by specialized staff and the spare parts used must be original. Therefore, it is necessary to apply to the reseller who sold the equipment.

2 Storage



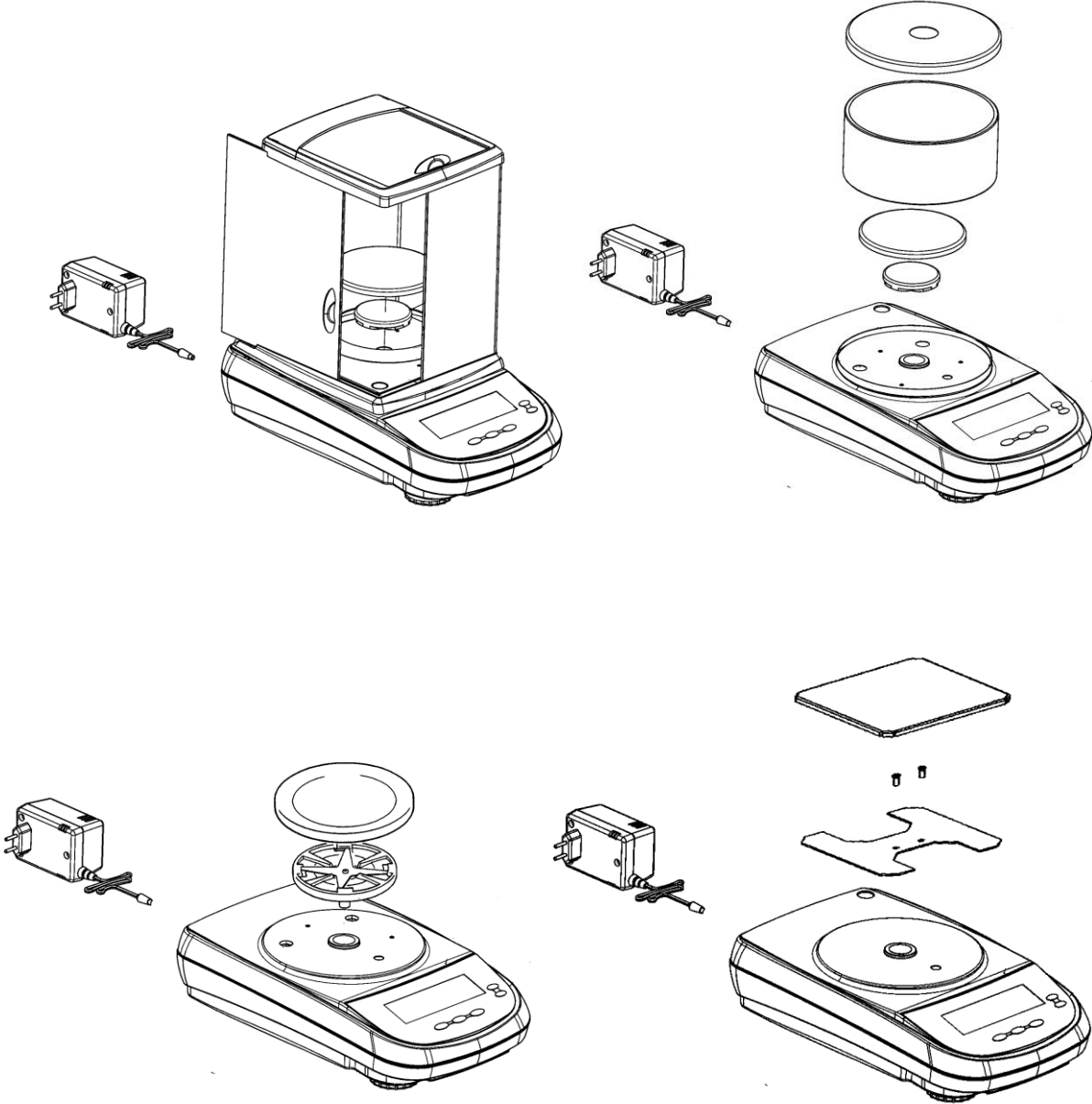

- **Storage temperature:** +5 °C...+40°C
- **Storage humidity** 45% - 75%.
- **Keep package** in the case the balance should be sent back to the factory for service. Disconnect the cables and the accessories for avoiding damages during transportation.
- **Do not place** the balance in extreme temperature and humidity condition and avoid the balance to take strong hit.

3 Weighing pan assembly

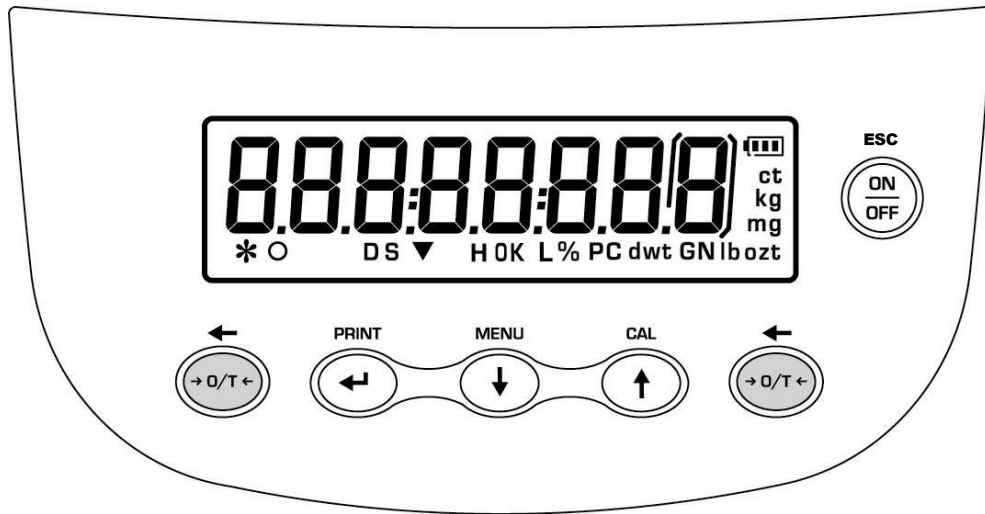

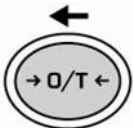
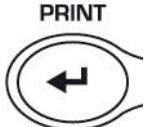
4 Keyboard and display



	Standby (OFF/ON) or escape ESC.	*	Stability indicator
	TARE or zero button.	O	Zero indicator
	Selection CONFIRM or SEND data to printer.	%	Percentage weighing
	Balance setup MENU button.	PC	Piece counting
	Balance CALIBRATION button.		Battery charge indicator
		▼	Insert data mode
		H	Upper threshold
		L	Lower threshold
		DS	Density measure mode
		ct,	Measure unit
		ozt, lb, GN, dwt, Kg, mg	

5 Overview

5.1 Front part of the balance

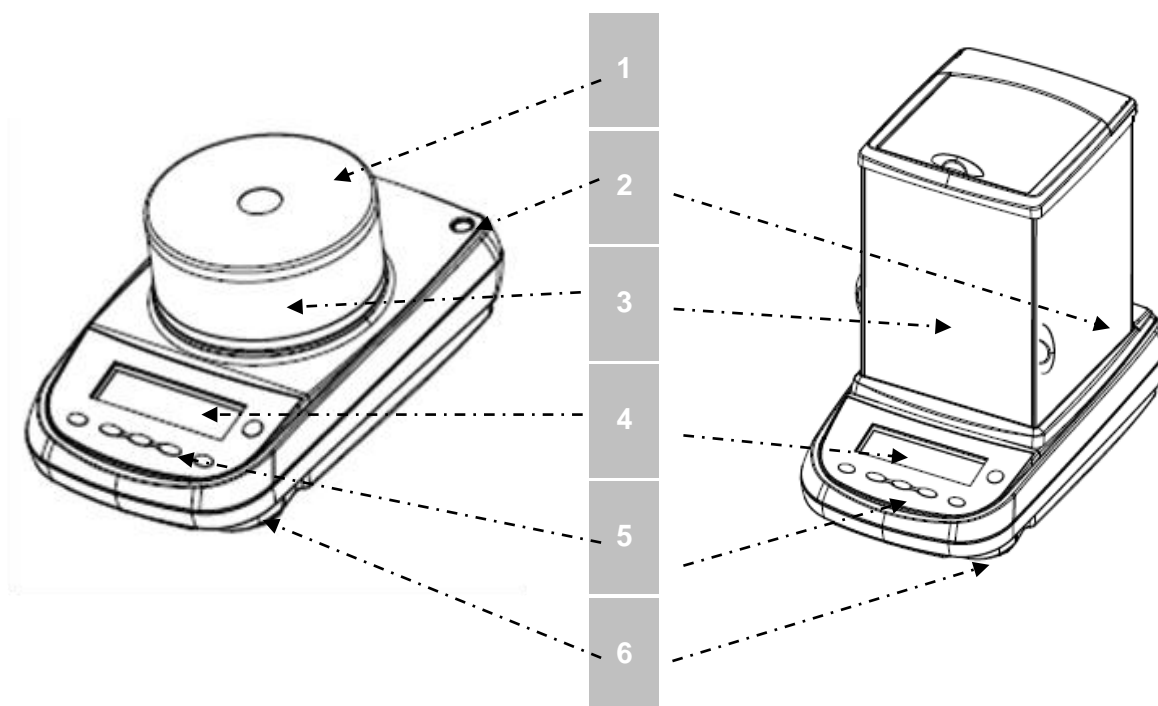

Fig.1
Balance with circular and three-panes windshield

Name and function	
1	Cap of windshield
2	Levelling bubble
3	Windshield
4	LCD display
5	Function buttons
6	Levelling feet

5.2 Rear and bottom part of the balance

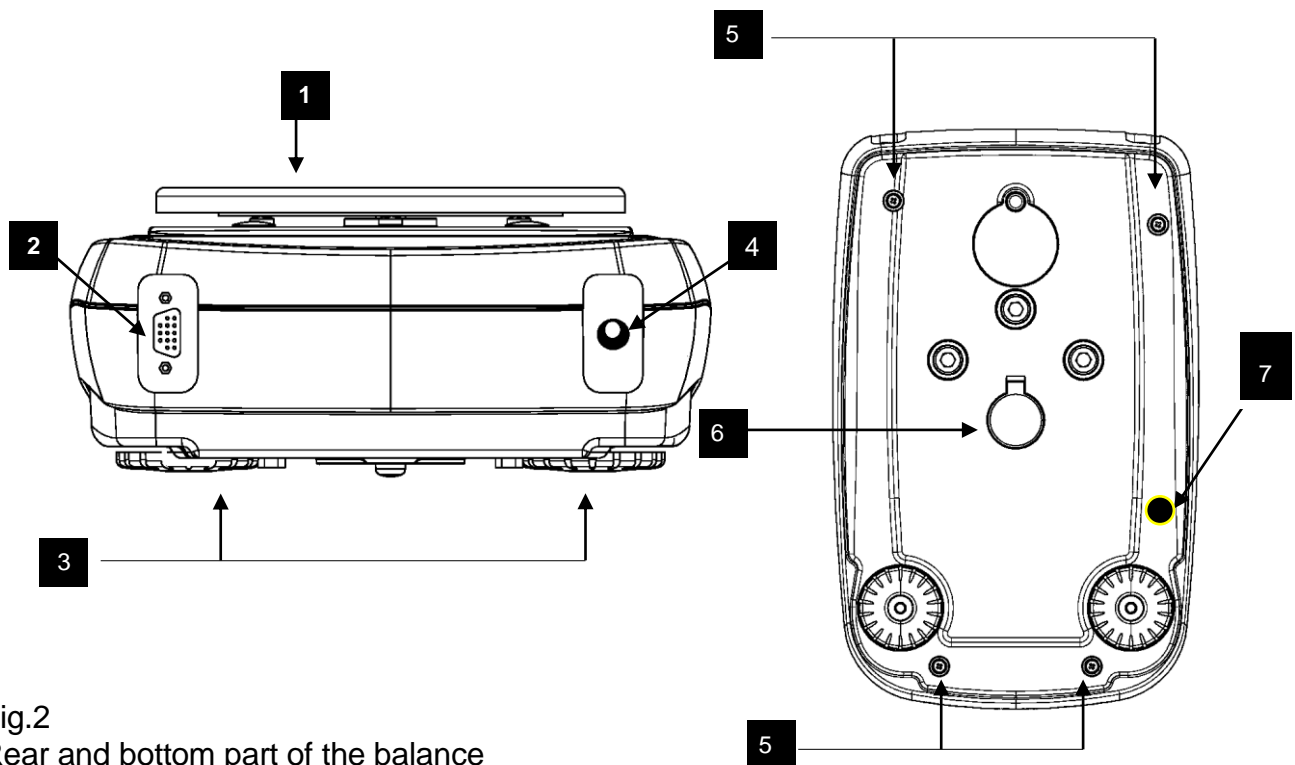

Fig.2
Rear and bottom part of the balance

Name and function (Fig.2)	
1	Weighing pan
2	9 poles (pin) female connector for RS232 interface for printer/PC/external keyboard
3	Levelling feet
4	connector for power supply
5	Screws for balance closing. In models with 4 feet it is necessary first to remove the two rear feet (one fixed and one moving) to access to the closing screws
6	Hook for under-balance weighing. Hook not available in internal calibration models and for verified balances. Note: please remove the cap to access the hook
7	Protection screw for autocalibration motor (<u>only for models with internal calibration</u>). ATTENTION: remove this screw by hand as soon as the balance is removed from its package

5.3 Rear and bottom part of the balance, models Version Square Pan

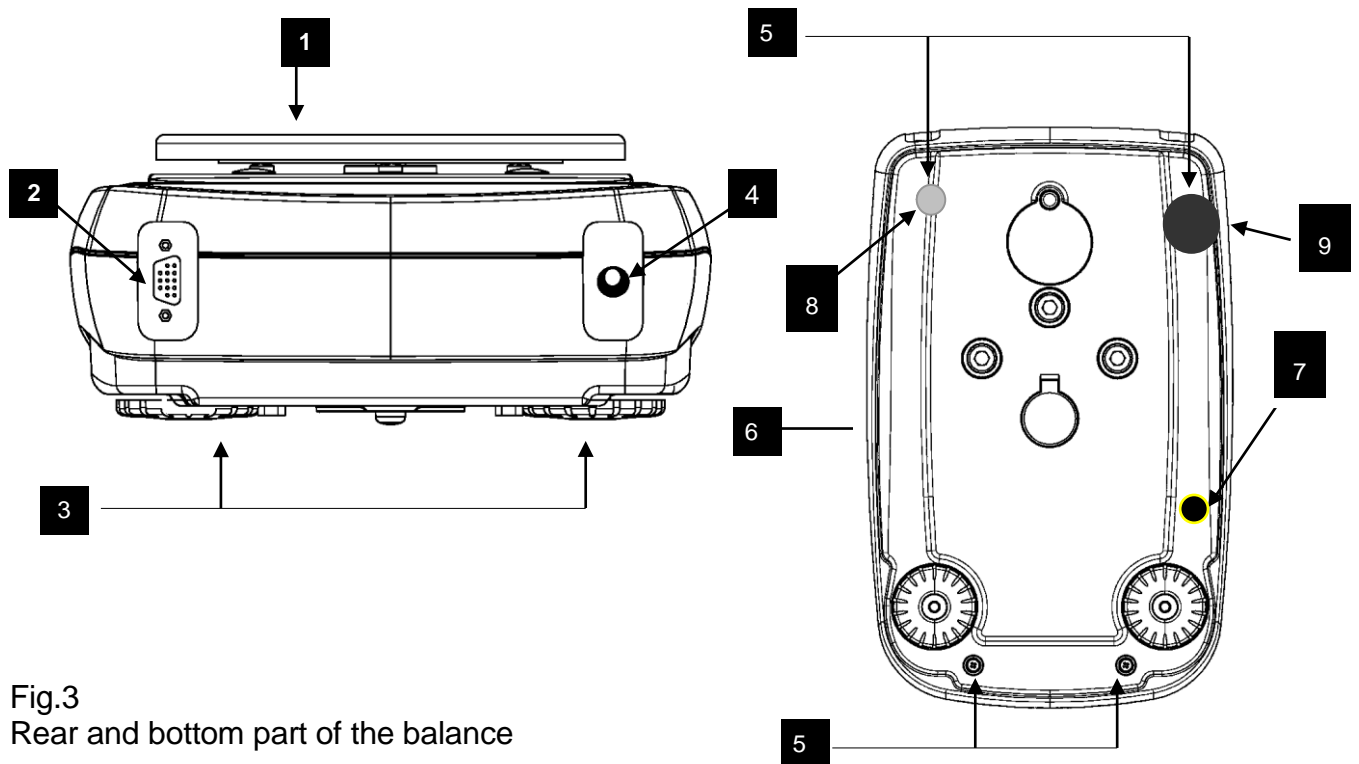

Fig.3
Rear and bottom part of the balance

Name and function (Fig.3)	
1	Weighing pan
2	9 poles (pin) female connector for RS232 interface for printer/PC/external keyboard
3	Levelling feet
4	connector for power supply
5	Screws for balance closing. In models with 4 feet it is necessary first to remove the two rear feet (one fixed and one moving) to access to the closing screws
6	Hook for under-balance weighing. Hook not available in internal calibration models and for verified balances. Note: please remove the cap to access the hook
7	Protection screw for autocalibration motor (<u>only for models with internal calibration</u>). ATTENTION: remove this screw by hand as soon as the balance is removed from its package
8	Adjustable rear
9	Fixed rear feet

5.4 Ioniser (only for models -ION)

Using the ioniser:

Keys descriptions.

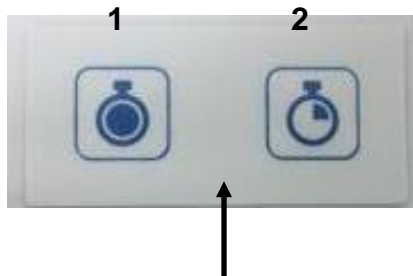

1 Activation button ioniser in continuous mode. (Auto power off after 8 hours of operation)

2 Activation button ioniser in timed mode. (Operation for 2 minutes)

N.B. to switch from one function or to turn off the device, press either one of the two keys.

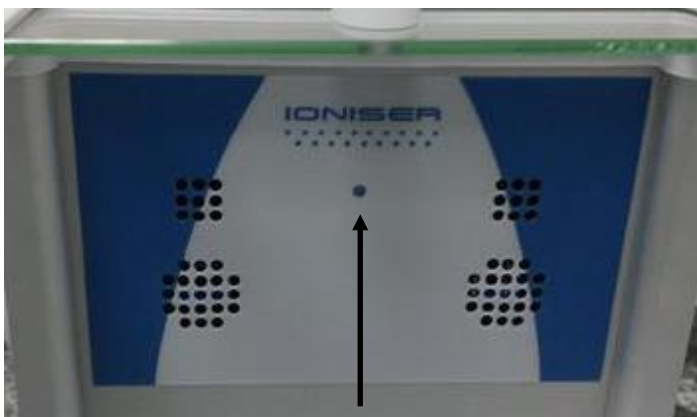

LED green: powered ioniser.

Solid red LED: ioniser activated in continuous mode.

Flashing red LED: ioniser activated in time.

The ionizer is mounted in place of the rear glass in the models with resolution 0.0001 version -ION as in the photo.



Technical data Ioniser

Distance "sample ion source"	c. 5 - 40 cm
Ozone concentration	0 ~ 0.05 ppm (2cm from ion source)
Ambient conditions	0 – 50°C, 20 ~ 80% air humidity (non-condensing)
AC adapter (primary)	AC 100-240V, 50/60Hz
Rated electric power supply	DC 12V, 500mA
Pollution degree	2
Overvoltage category	Category II
Altitude	Up to 2000m
Installation site	Device may only be used indoors

6 Weighing



For verified Balances models at switch on it will appear “WARM UP” on display and countdown will start

After having connected the balance to AC outlet, it will perform an internal circuits test, after that the balance will set itself in stand-by mode.



6.1 Stand By

From “STAND BY” mode:

- Press **ON/OFF** button to bring balance to work conditions.
- Press again **ON/OFF** button to return to “STAND BY” condition.



6.2 Simple weighing

Load the sample to weigh on the pan and read the value on display as soon as the stability symbol * (star) appears



The digit that represents the verification division “e” is rounded with a frame

7 Calibration

Electronic balances take mass measurements making use of gravity (g). Difference of latitude in geographic areas and altitude will vary gravity acceleration value (g). Therefore, for accurate measurements, the balance must be adjusted to the local environment. This adjustment is accomplished by calibration function.

7.1 External calibration



For verified Balances models the External calibration function is locked

Calibration is accomplished by pressing **CAL** button.

1. Press **CAL** button when pan is empty, dashes are displayed on the display.

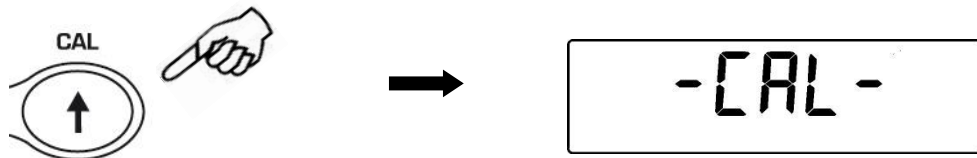

2. When calibration weight value starts to flash, load the weight on the pan.

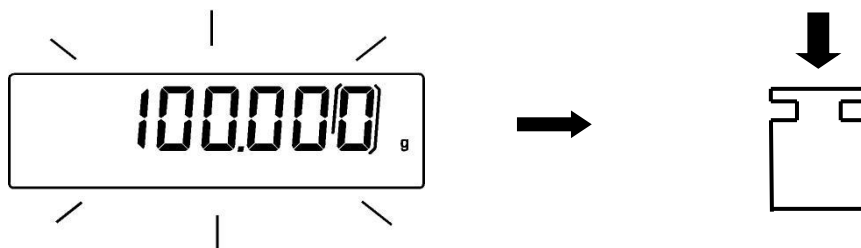

3. The display will stop flashing, indicating calibration weight value. Once the calibration is effected will be shown the value of the calibrated weight and the current unit of measure.
4. Unload calibration weight from the pan. The balance is ready for weighing operations.

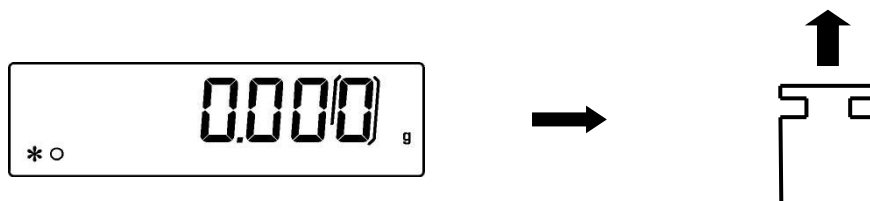

NOTE: if there is interference during calibration process, an error message will be displayed.

Moreover, it is possible to calibrate the balance with a calibration weight higher than the one set by default:

1. Press and keep **CAL** button pressed with empty pan until the acoustic alarm stops, then release the button. On display it will be visualized the string **"-CAL-**", followed by flashing string **"LOAD"**.

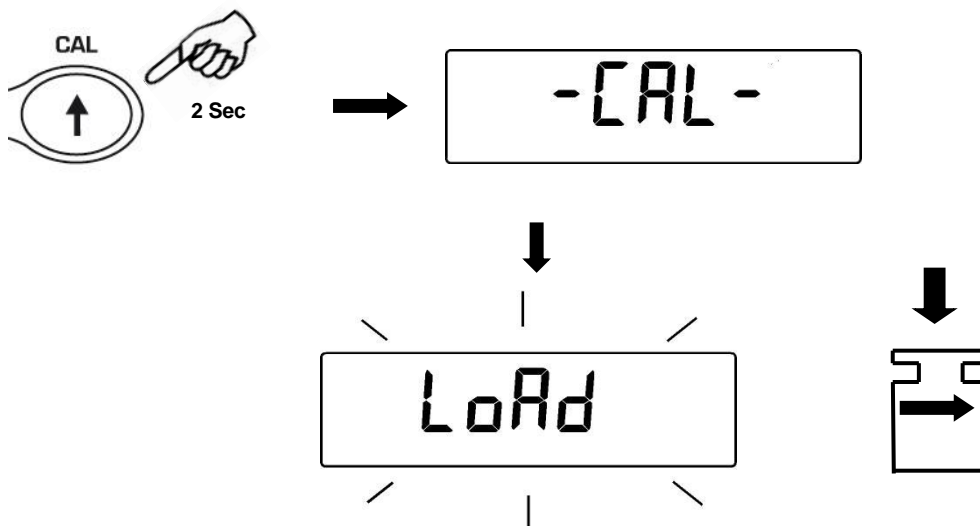

2. Load on the pan a weight equal higher or lower than default calibration weight; the balance will recognize it as valid weight if equal or higher than calibration weight as long as it is a whole number in comparison with the most meaningful digit of calibration weight .

e.g.: if calibration weight is 200g, it will be possible to calibrate the balance with values from 100g 200g, 300g, 400g up to the highest limit of balance weighing range.

The message **"LOAD"** on display will stop flashing. Once calibration has been effected, the value of calibrated weight will be displayed.

3. Unload calibration weight. The balance is ready for weighing operations.

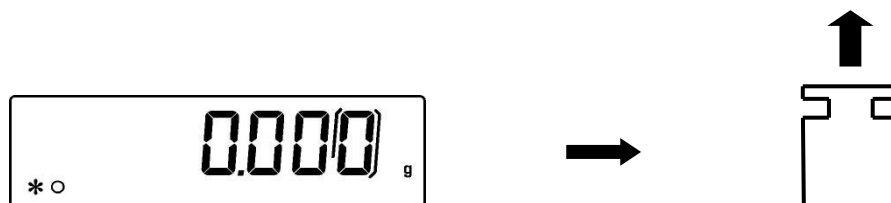

NOTE: if there is interference during calibration process, an error message will be displayed.

7.2 Internal calibration

* only for models with internal calibration "-i"

In these balance models there are 4 calibration modes:

From display zero condition, press and keep pressed the **MENU** button until the acoustic alarm gets mute, then release the button. The message “**unitS**” will be visualized on display, press then **MENU** button until you visualize “**Calib**” on display. Press **PRINT** to confirm.

1. Select the calibration mode you wish by pressing **MENU** button in sequence:

- **AUT-CAL**: auto calibration
- **I-CAL**: internal calibration*
- **E-CAL**: external calibration*
- **TEC-CAL**: technical calibration*

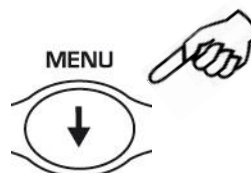

***Locked for verified balances models**

2. Press **PRINT** button to confirm “**AUT-CAL**”, “**I-CAL**”, “**E-CAL**”.
To confirm “**TEC-CAL**” keep pressed the **PRINT** button until the acoustic alarm gets mute.
3. After selection, the balance returns to calibration menu. Press and keep pressed **MENU** button until the acoustic alarm gets mute, then release the button. Balance is again ready for weighing operations.

7.2.1 Autocalibration (AUT-CAL)



This is Factory setting for verified balances models

The balance self-calibrates when the temperature variation exceeds the factory preset value and at factory preset time intervals, through the internal reference mass, and only if the balance pan is empty.

When the balance needs to perform the Automatic calibration, the display will show the following message:

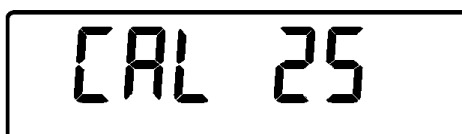

A 25-seconds countdown will start during which you can decide if:

- Stop the automatic-calibration procedure by pressing the “**ON/OFF**” button that will be delayed of 5 minutes

or

- Let the countdown finish so that the automatic calibration starts

Note: during the countdown do NOT load anything on the plate!

In this mode, it is also possible to carry out the calibration with the internal reference mass by pressing the **CAL** button at any moment, first ensuring that no weight is loaded on the plate.

1. Press **CAL** button with empty pan.
The message “**CAL**” will be displayed and balance calibration will be effected automatically.

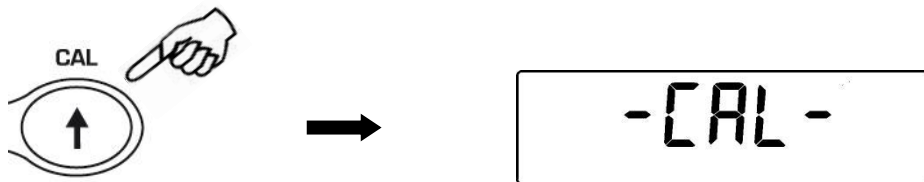

2. At the end of calibration, balance returns to normal weighing conditions.



If calibration is not finished due to vibrations or air flows, then the message “**CAL bUt**” is displayed. Press again **CAL** button. If the problem repeats then select external calibration and contact the product supplier.

7.2.2 Internal calibration (I-CAL) [locked for verified balances]

The balance calibrates itself with internal reference mass **ONLY** on user command by pressing **CAL** button.

Before effecting internal calibration, be sure that there’s no weight loaded on the balance pan.

7.2.3 External calibration (E-CAL) [locked for verified balances]

The balance is calibrated through an external reference mass (**NOT** provided with models with internal calibration).

(Follow procedures described at paragraph 7.1)

7.2.4 Technical calibration (TEC-CAL) [locked for verified balances]

This function allows storing the value of internal reference mass whenever checking or assistance actions require it.

1. After having selected the **TEC-CAL** calibration mode, press **CAL** button at empty pan. It will be displayed “CAL”.

2. When the  value of calibration weight start flashing on display, load the weight on to the balance pan.

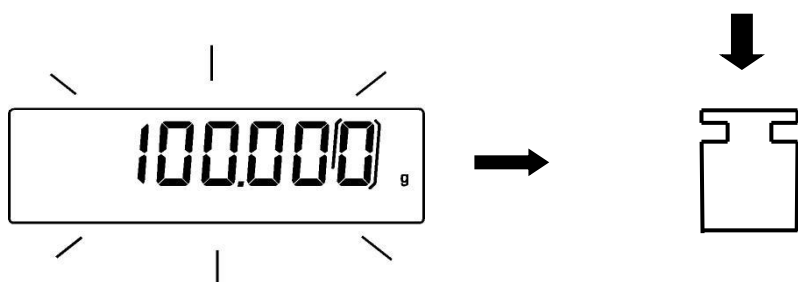

3. Wait the acoustic alarm and that the displayed calibrated weight value stops flashing, then unload the weight from balance pan.
4. When string “**0.000**” is displayed continuously, then press and keep pressed the **PRINT** button. This starts the internal weight value automatic acquisition and store. During the acquisition cycle, the display will show “**TEC-MEM**”.

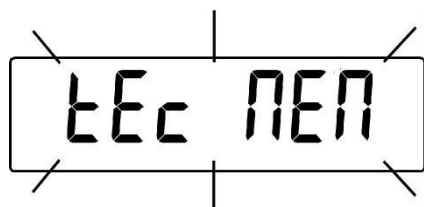

5. After having stored the value of internal calibration weight, balance returns to normal weighing conditions.
6. Return to calibration menu as described at paragraph 6.2 and set the desired calibration mode: internal, automatic or external..



ATTENTION : this procedure must be effected only using E2-class reference masses.

7.3 Verification

General introduction:

According to EU directive 90/384/EEC balances must be verified if they are used for legally controlled area as follows:

- a) For commercial transactions if the price of goods is determined by weighing.
- b) For the production of medicines in pharmacies as well as for analyses in the medical and pharmaceutical laboratory.
- c) For official purposes.
- d) For manufacturing final packages.

In cases of doubt, please contact your local trade in standard.

Verification instructions

An EU type approval exists for balances described in their technical data as verifiable. If a balance is used where obligation to verify exists as described above, it must be verified and re-verified in regular intervals.

Re-verification of a balance is carried out according to the respective national regulations. The legal regulation of the country where the balance is used must be observed!

After verification the balance is sealed at the indicated positions.

Verification of the balance is invalid without the "seal".

Balances with obligation to verify must be taken out of operation if:



- **The weighing result of the balance is outside the error limit.** Therefore, in regular intervals load balance with known test weight (ca. 1/3 of the max. load) and compare with displayed value.
- **The re-verification deadline has been exceeded.**

8 Tare function

1. Load the container on the pan. The display will show the weight.

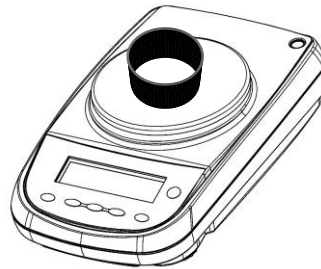

2. Press **O/T** button. "O-t" string will be displayed

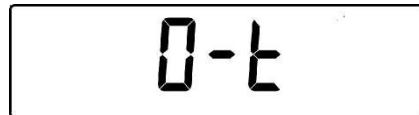
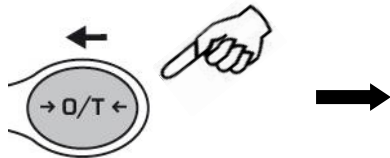

3. After reaching stability, the value "0.000" will be displayed. If the stability is not reached (due to air flows or vibrations or other disturbs) the dashes will remain displayed.



4. Load the objects to weigh in the container. Read net weight value on display.

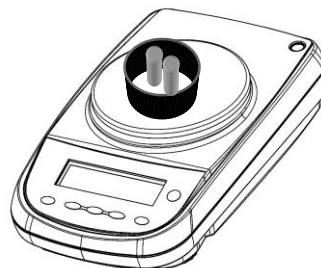

8.1 Manual tare function



Function not available in verified balances

This function allows to insert manually the tare values.

1. Press and keep pressed the **O/T** key whit no objects on the weighing pan until the beep alarm stops, then release the key.
2. Will be shown on the display the following string:

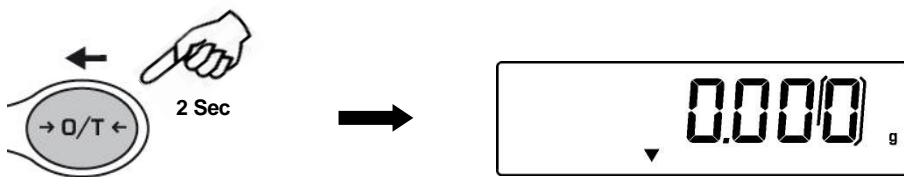

3. Insert now the desired tare value using the keys **CAL** and **MENU** for increase or decrease the value, and press the **O/T** key for skip to the following digit. During the value insert mode, if keep pressed the **O/T** key is possible to delete the inserted value.

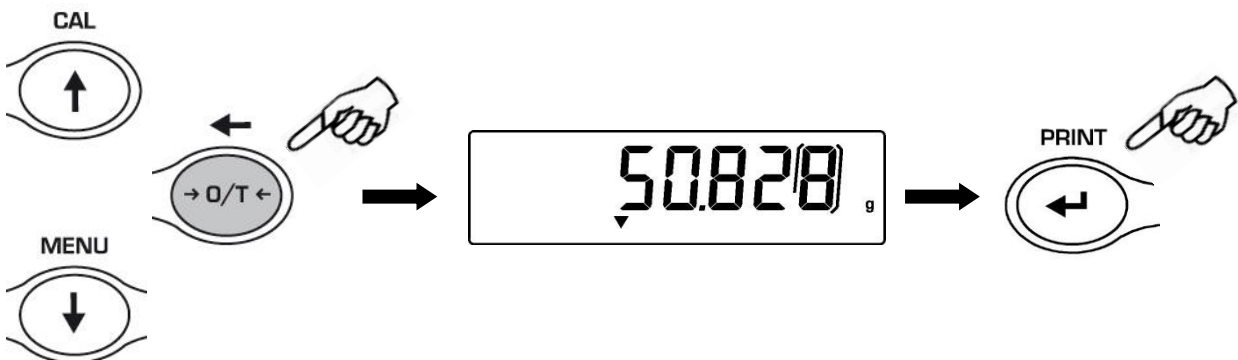

4. Press **PRINT** key to confirm the value inserted.

8.2 Optional alphanumeric external keyboard



Function locked in verified balances

If you have the optional external alphanumeric keyboard, then it is possible to perform tare also by pressing the **TARE/DELETE** button of this keyboard, in the same way as previously described.

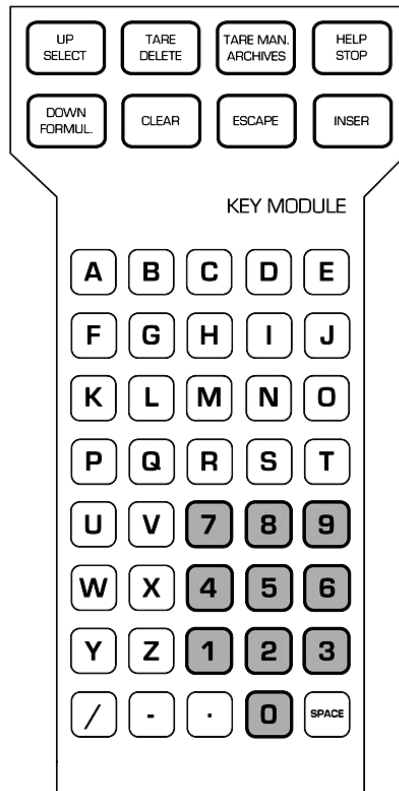

It's also possible to manually insert a known tare value by the keypad.

1. Press **TARE MAN** button on the alphanumeric keyboard. An arrow will appear on the balance display along with the previous value of manual tare, if one has been inserted before.

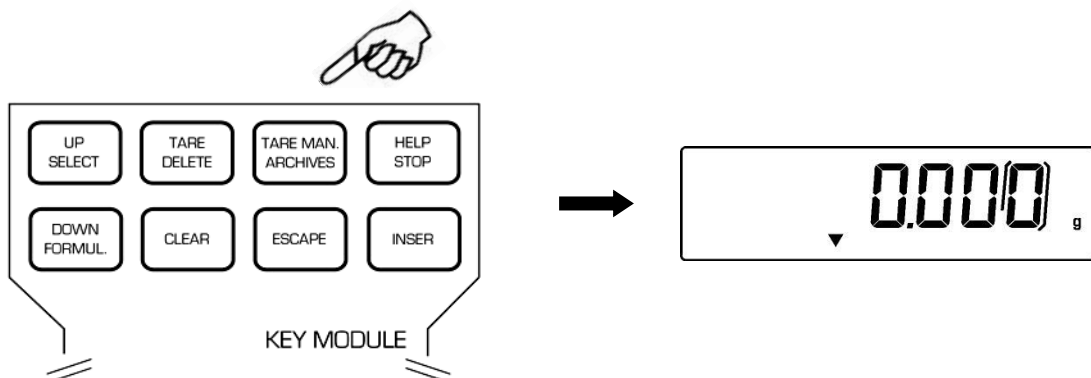

2. Press **CLEAR** to set at zero the previous value (if any) then insert the new value using the alphanumeric buttons placed on the bottom part of alphanumeric keyboard.



3. Press **INSER** to confirm.
4. Press **ESCAPE** button to escape from tare condition.

To set to zero the value of the manual tare inserted by means of alphanumeric keyboard, effect a normal operation of tare by pressing **O/T** button of the balance or with **TARE/DELETE** button placed on the optional alphanumeric keyboard.

9 Weight units

The scale can be set to display the weight in the different units, one primary (**unit1**) and one secondary (**unit2**).

When we supply the scale, the default unit of measurement is **unit1**.

1. From display zero condition press and keep pressed the **MENU** button until the acoustic alarm gets mute, then release the button. The message “**unit 1**” will be displayed then press **PRINT** to confirm.

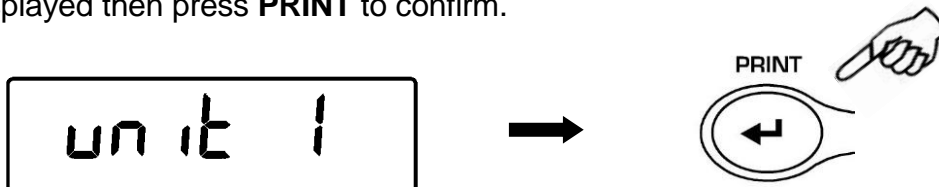

2. It will be displayed “**GRAM**” unit. Pressing the **MENU** or **CAL** button, it will be possible to scroll forward or backward the weight units menu.

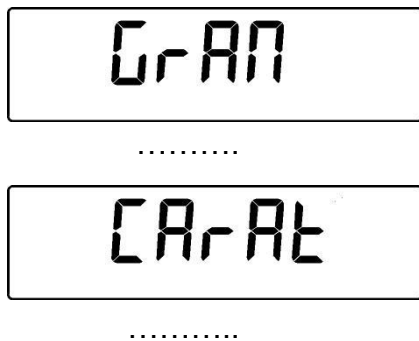

3. Press **PRINT** button to confirm or **MENU** button to shift to the other weight unit.

SYMBOL	UNIT	CONVERSION FACTOR 1g =
GrAM	GRAM	1.
MiLLi Gr	MILLIGRAMMES	0.001
CArAt	CARAT	5.
OuncE	ONCE	0.035273962
Pound	POUND	0.0022046226
PEnn.	PENNYWEIGHTS	0.643014931
OuncETr.	ONCE TROY	0.032150747
GrA in	GRAIN	15.43235835
tAEL Hon	HONG KONG T AEL	0.02671725
tAEL SGP	SYNGAPORE T AEL	0.02646063
tAEL roc	R.O.C. T AEL	0.02666666
MoMME	MOMME	0.2667

- After setting **unit1** (by pressing the **PRINT** button to confirm), press the **MENU** button to select the second unit of measurement.
- The "**unit 2**" will be displayed, then press the **PRINT** key to confirm.

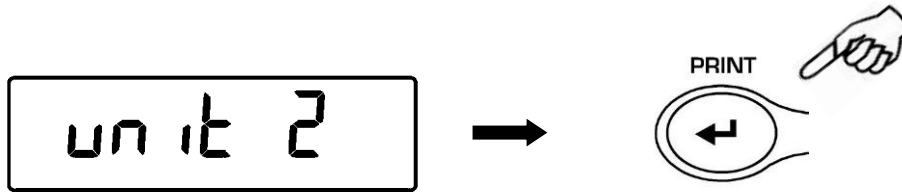

- The "**GRAM**" unit will be displayed. Pressing the **MENU** or **CAL** key will now be possible to scroll backwards or forwards the secondary units menu.

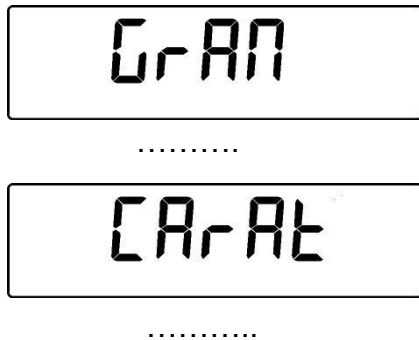

- Press the **PRINT** key to confirm or **MENU** to change to another unit of measurement (the units of measurement available are the same as those listed in point 3).
- To escape from parameters setup menu, press the **MENU** button until the acoustic alarm gets mute, then release the button.
- The balance returns to normal weighing conditions.



It is useful to set a second unit of measure when it is necessary to quickly display the result of a weighing in two different units.

10. By setting both units of measurement, returns to normal weighing condition, it will be sufficient to press the **PRINT** button until the acoustic alarm gets mute, then release the button to switch from one unit of measurement to another.

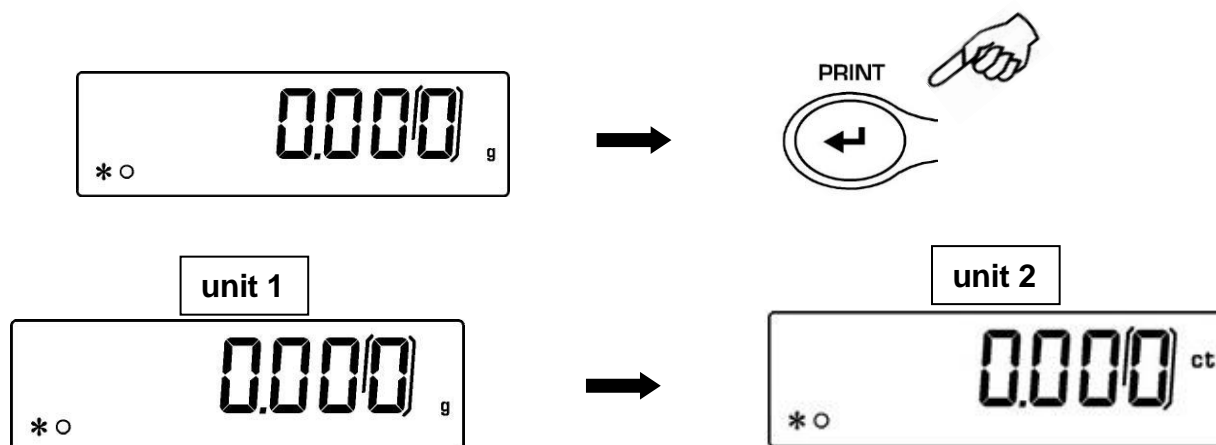

N.B. Putting the balance in **Stand-by** status using the **ON / OFF** button, the weight in the last selected measurement unit will be displayed when the power is turned on again.

Instead, by disconnecting the instrument from the electrical network, when it is switched on again, the weight will be displayed in the unit of measure corresponding to **unit1**.

10 PC communication setting

Connect the balance to PC with proper cable (par. 25)

1. From zero display condition press and keep pressed the **MENU** button until the acoustic alarm gets mute, then release the button. It will be displayed the string “**unitS**”, then press the **MENU** button until it is displayed “**PC-PRTR**” message then confirm by pressing **PRINT** button.

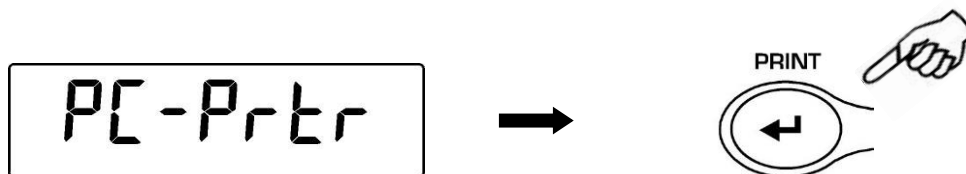

2. Press the **MENU** button until the “**PC cont**” is displayed to choose continuous print or “**PC CMd**” to choose print to PC at user command, then press the **PRINT** button to confirm the choice.

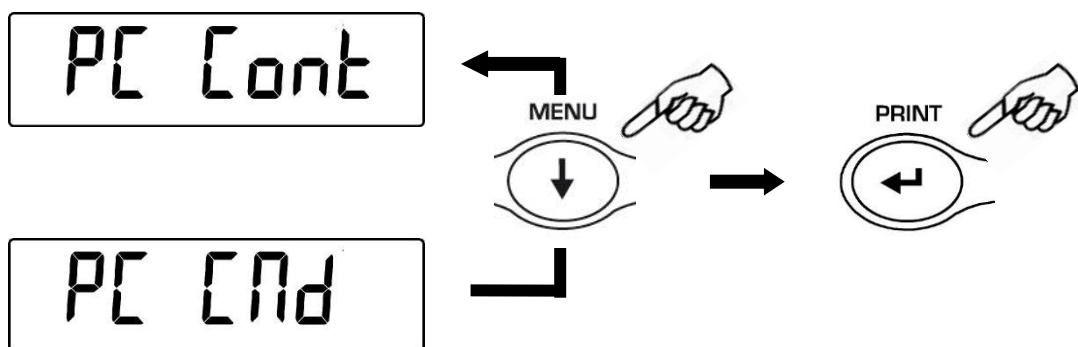

3. After having selected the desired transmission mode, press the **MENU** button to go to next parameter or the **CAL** button to go to previous.
4. To escape from parameters setup menu, press the **MENU** button until the acoustic alarm gets mute, then release the button. The balance returns to normal weighing conditions.
5. The balance returns to normal weighing conditions sending the data continuously or at user command.



NOTE: select speed transmission (par. 12)

11 Printer serial communication selection

Connect the balance to the printer using the proper cable (par. 25)

1. From zero condition on display, press and keep pressed the **MENU** button until the acoustic alarm gets mute, then release the button. The message “unitS” will be displayed, then press **MENU** until you read the message “PC-PRTR” on display and confirm pressing **PRINT** button



2. To select the data print mode, press **MENU** until the message “PRINT” is displayed or “TLP50” if you want to connect the TLP50 printer for printing on labels or on paper with date and time.
3. Press **PRINT** to confirm.

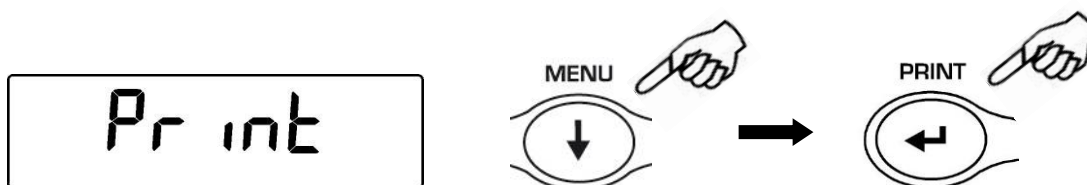

4. After having selected the data print mode, press **MENU** button to go to next parameter or **CAL** button to go to previous one.
5. To escape from parameters setup menu, press **MENU** button until the acoustic alarm gets mute, then release the button. The balance returns to normal weighing conditions, ready to transmit data each time the **PRINT** button is pressed.



NOTE: select speed transmission (par. 12)

12 Transmission speed selection

1. From zero condition on display, press and keep pressed the **MENU** button until the acoustic alarm gets mute, then release the button. The message “unitS” is displayed, then press **MENU** button until the message “BAUD RT” is displayed and confirm by pressing the **PRINT** button.

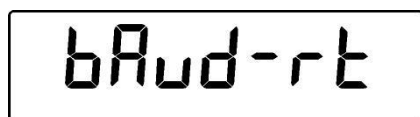

bAud-rt

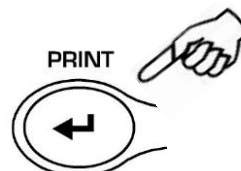

2. Select serial data transmission speed (1200-2400-4800-9600 baud). Pressing **MENU** or **CAL** buttons it will be possible to scroll forward or backward through the different transmission speeds, then confirm your choice by pressing **PRINT** button.



br 1200



br 2400



br 4800



br 9600

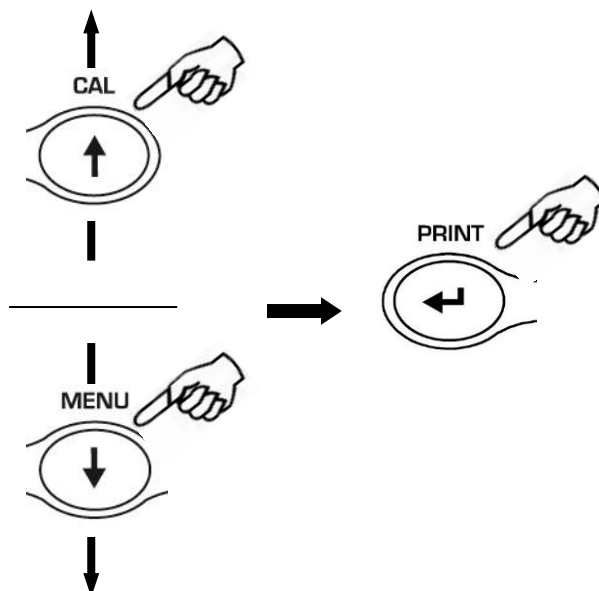

3. After having selected the transmission speed you wish, press the **MENU** button to go to next parameter or **CAL** button to go to previous one.
4. To escape from parameters setup menu, press the **MENU** button until the acoustic alarm gets mute, then release the button.
5. The balance will return to standard weighing conditions.



*o 0.000 g

13 Autozero function

Autozero is an automatic correction of a possible zero drift.

- **Au0 OFF** = autozero disabled
- **Au0 1** = soft autozero
- **Au0 2** = medium autozero *
- **Au0 3** = heavy autozero *
- **Au0 3E** = heavy autozero over all range *

* locked in verified balances

1. From zero condition on display, press and keep pressed the **MENU** button until the acoustic alarm gets mute, then release the button. The message “unitS” is displayed, then press **MENU** button until the message “**AUTO 0**” is displayed, then press **PRINT** to confirm.

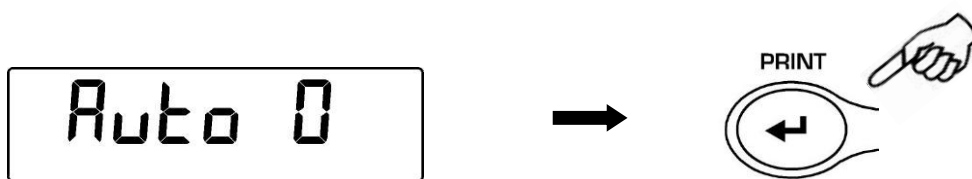

2. Pressing **MENU** or **CAL** button it will be possible to scroll forward or backward through the different autozero levels, select the one you wish and confirm it by pressing the **PRINT** button.

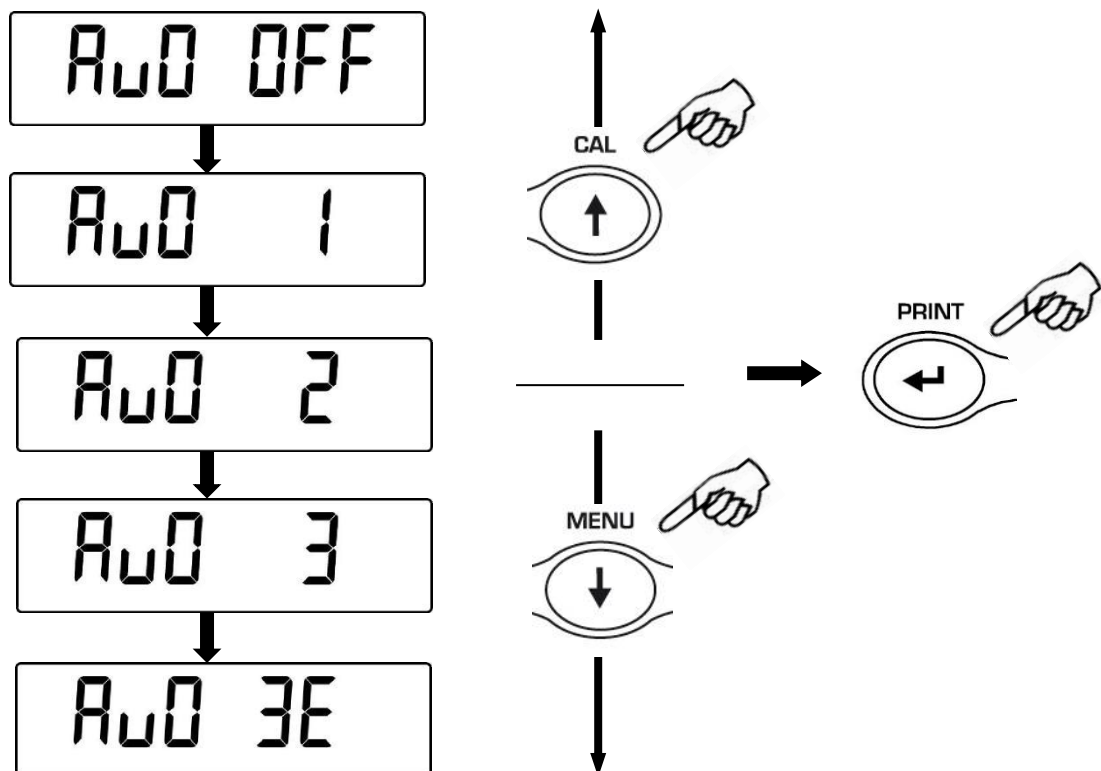

3. After having selected the autozero level you wish, press the **MENU** button to go to next parameter or **CAL** button to go to previous one.
4. To escape from parameters setup menu, press the **MENU** button until the acoustic alarm gets mute, then release the button.
5. The balance will return to standard weighing conditions.

14 Filters selection

It is possible to adapt the balance to the different environment conditions thanks to the selection of three filters:

- **FILTER 1:** proportion of ingredients condition
- **FILTER 2:** stable conditions
- **FILTER 3:** unstable conditions

1. From zero condition on display, press and keep pressed the **MENU** button until the acoustic alarm gets mute, then release the button. The message “unitS” is displayed, then press **MENU** button until the message “FILTER” is displayed then confirm it by pressing the **PRINT** button.

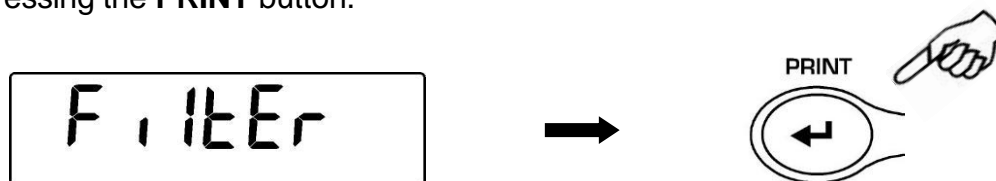

2. Pressing **MENU** or **CAL** button it will be possible to scroll forward or backward the different filtering levels, select the one you wish and then confirm it by pressing the **PRINT** button

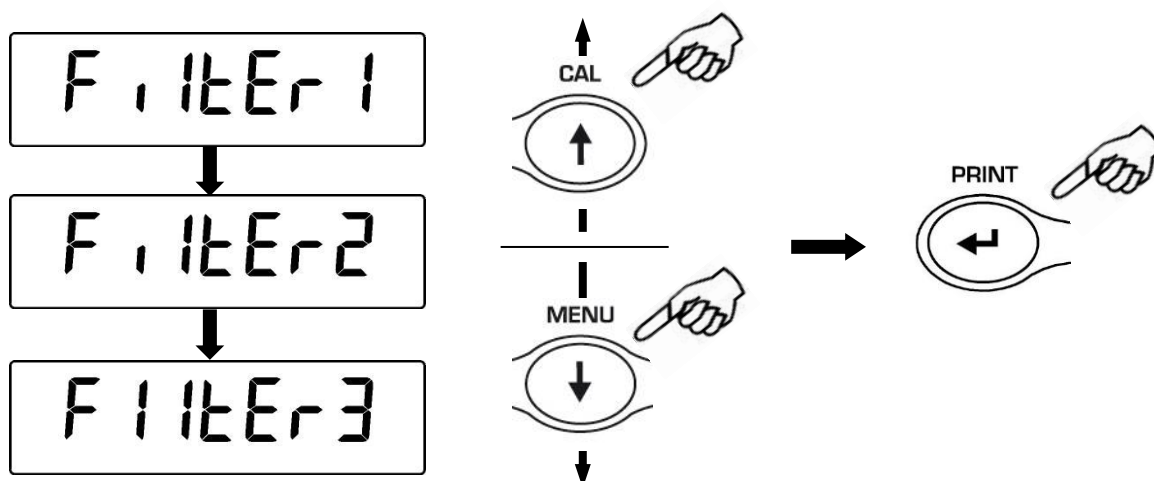

3. After having selected the filtering level you wish, press the **MENU** button to go to next parameter or **CAL** to go to previous one.
4. To escape from parameters setup menu, press the **MENU** button until the acoustic alarm is over, then release the button.
5. The balance will return to standard weighing conditions.



NOTE: It is suggested to use FILTER 1 when proportion of ingredients must be performed

15 Stability function

The stability symbol is displayed when the weight is stable inside a defined range

- **STAB 1** = for stable environments
 - **STAB 2** = for not so stable environments
 - **STAB 3** = for unstable environments
1. From zero condition on display, press and keep pressed the **MENU** button until the acoustic alarm gets mute, then release the button. The message “**unitS**” is displayed, then press **MENU** button until the message “**StAbiL**” is displayed, then confirm this by pressing the **PRINT** button.
 2. Pressing **MENU** or **CAL** button it will be possible to scroll forward or backward the different stability levels, select the one you wish and then confirm it by pressing the **PRINT** button.

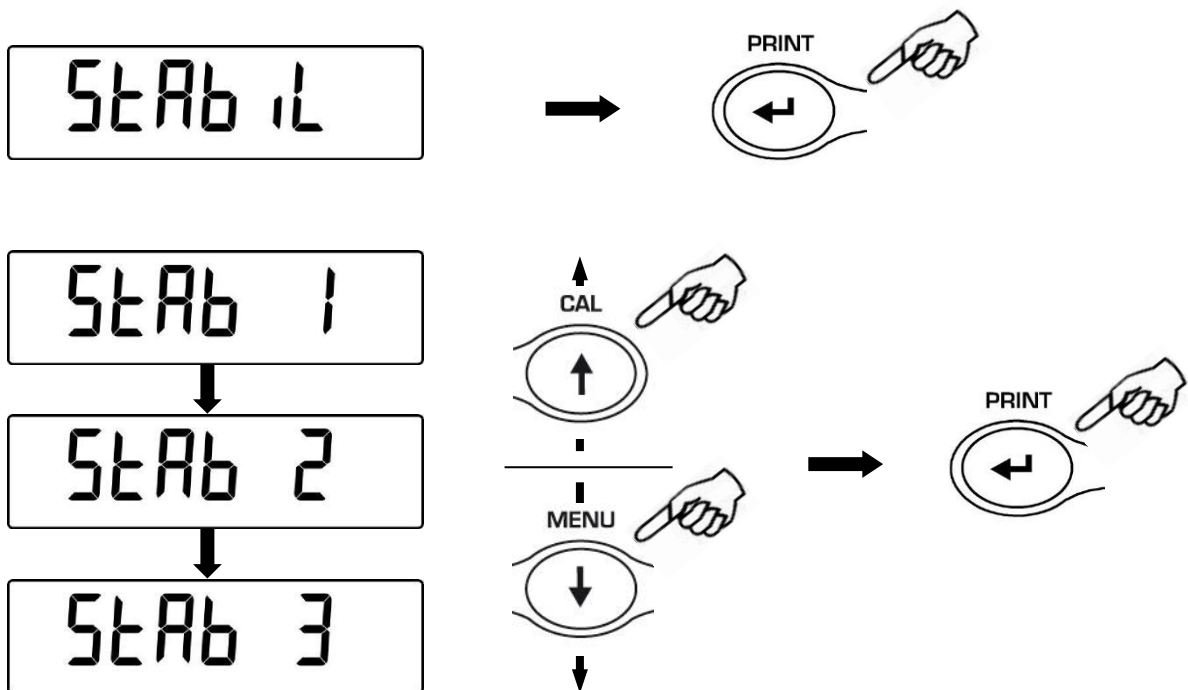

3. After having selected the stability level you wish, press the **MENU** button to go to next parameter or the **CAL** button to go to previous one.
4. To escape from parameters setup menu, press the **MENU** button until the acoustic alarm gets mute, then release the button.
5. The balance returns to normal weighing conditions.



16 Display Contrast regulation

It is possible to regulate the contrast level of display to have a comfortable view of the indication at different angles of usage.

There are 15 different levels of regulation:

1. From zero condition on display, press and keep pressed the **MENU** button until the acoustic signal gets mute, then release the button. The message “unitS” is visualized, now press the **MENU** button repeatedly until the message “contr ” is displayed and confirm this by pressing the **PRINT** button

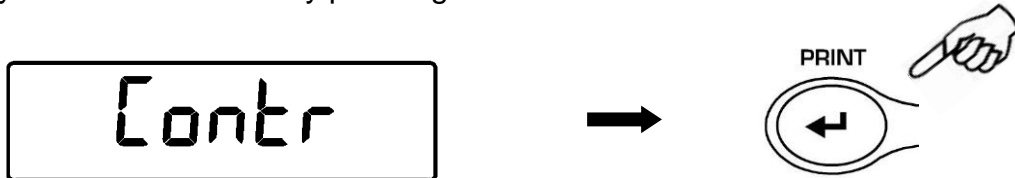

2. Now, pressing the buttons **MENU** or **CAL** it is possible to increment or decrement the level of the display contrast; select the one desired and confirm by pressing the **PRINT** button.

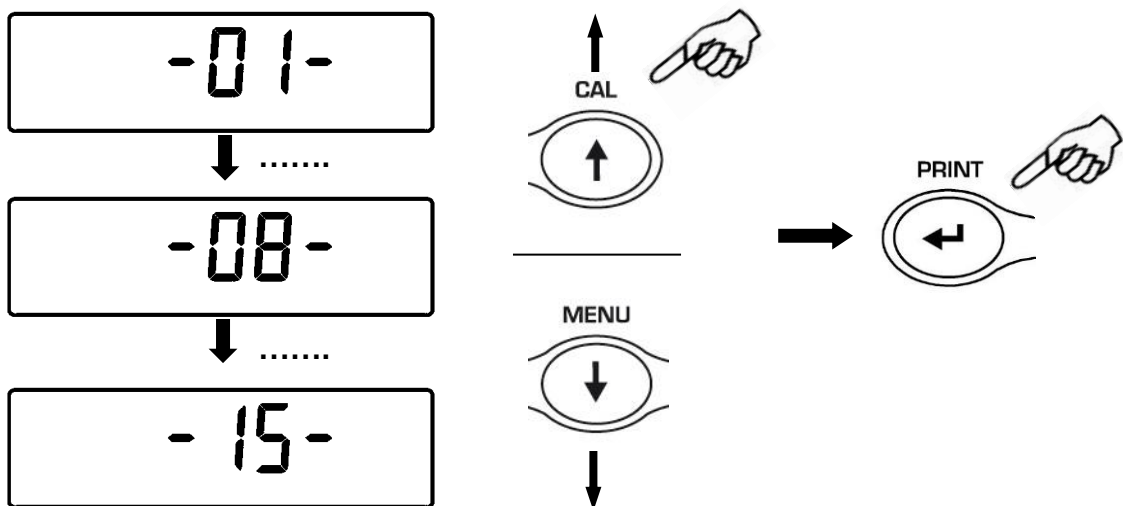

3. After you have confirmed the contrast level desired, press the **MENU** button to go to the next parameter or the **CAL** button to go to previous one.
4. To escape from parameters setup menu, press the **MENU** button until the acoustic alarm gets mute, then release the button.
5. The balance returns to normal weighing mode



17 Display Backlight setup

The balance display is equipped with backlight to make the indication more visible also during low light conditions.

There are 3 working modes:

- **ON** = light always switched ON
- **OFF** = backlight always switched OFF
- **AUTO** = backlight automatically switched on during weighing operations

1. From zero condition on display, press and keep pressed the **MENU** button until the acoustic alarm gets mute, then release the button. The message “unitS” is displayed, then press **MENU** button until the message “bLt”, then press the **PRINT** button to confirm this.

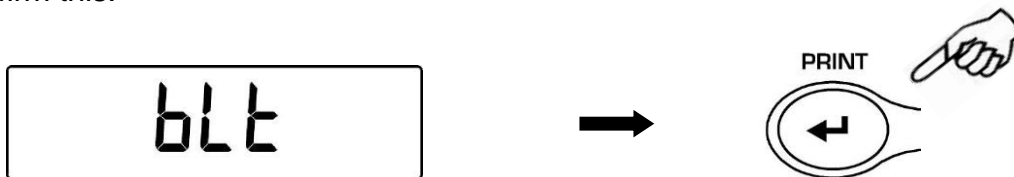

2. Pressing **MENU** or **CAL** button it will be possible to scroll forward or backward the different working modes, select the one you wish and then confirm it by pressing the **PRINT** button

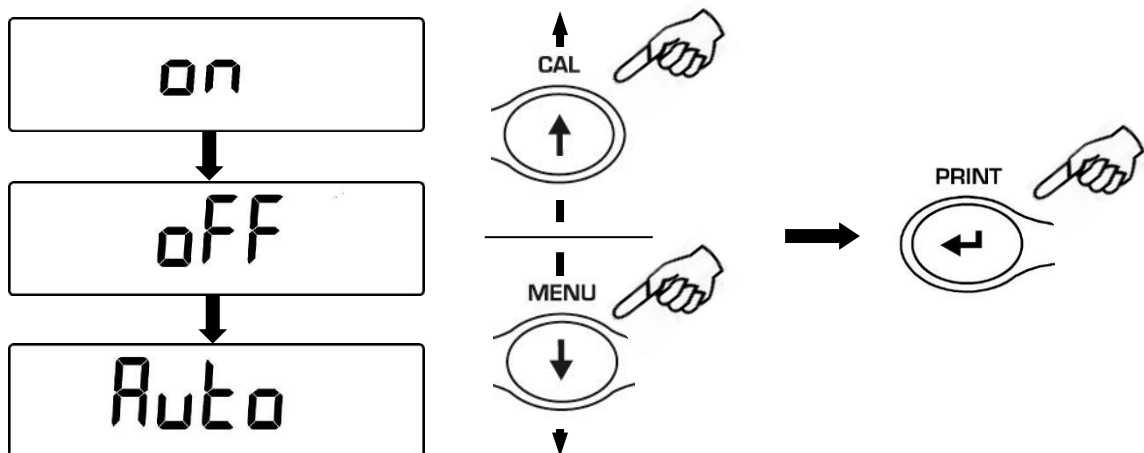

3. After having selected the backlight working mode you wish, press the **MENU** button to go to next parameter or the **CAL** button to go to previous one.
4. To escape from parameters setup menu, press the **MENU** button until the acoustic alarm gets mute, then release the button.
5. The balance returns to normal weighing conditions.



18 Auto Power-off function

This function allows to activate the automatic power-off of the balance after a defined balance idle-time. There are 4 auto power-off modes:

- disab** = Auto power-off disabled
- 2 Min** = Auto power-off after 2 minutes of idle time
- 5 Min** = Auto power-off after 5 minutes of idle time
- 15 Min** = Auto power-off after 15 minutes of idle time

1. From zero condition on display, press and keep pressed the **MENU** button until the acoustic alarm gets mute, then release the button. The message “**unitS**” is displayed, then press **MENU** button until the message “**tiME oFF**” then confirm by pressing the **PRINT** button.

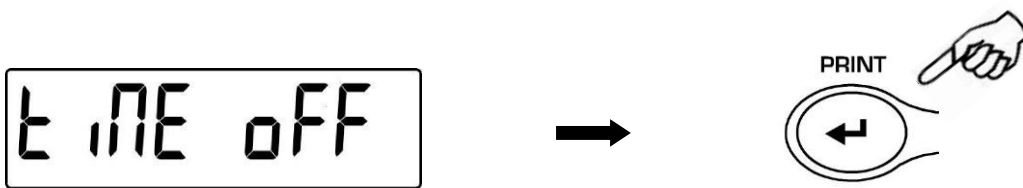

2. Pressing **MENU** or **CAL** button it will be possible to scroll forward or backward the different auto power-off modes, select the one you wish and then confirm it by pressing the **PRINT** button

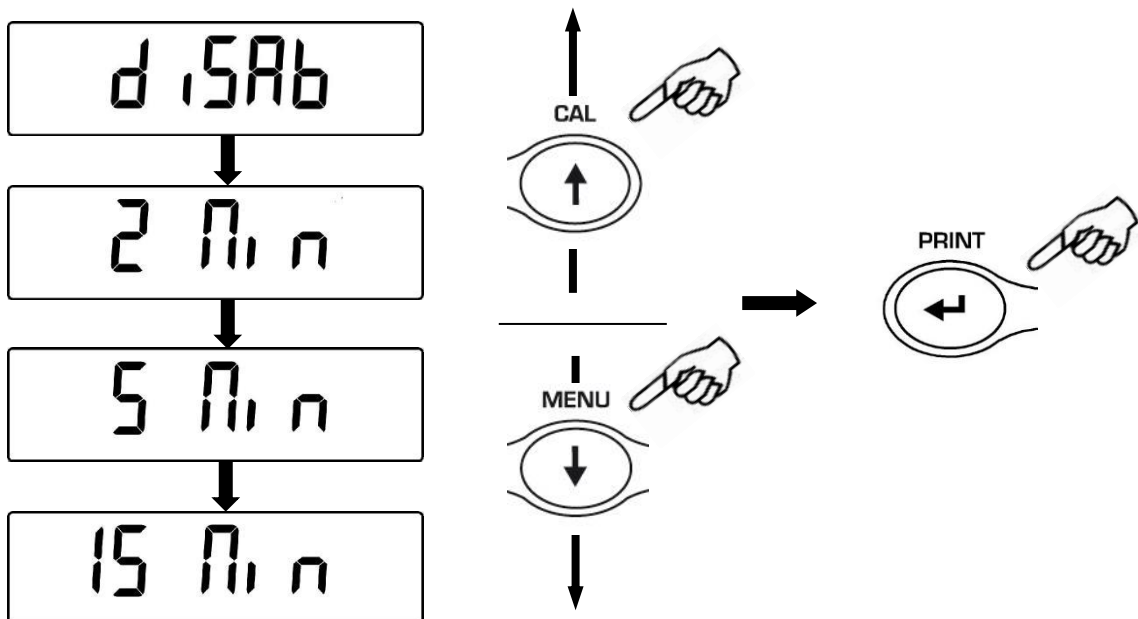

3. After having selected the auto power-off mode you wish, press the **MENU** button to go to next parameter or the **CAL** button to go to previous one.
4. To escape from parameters setup menu, press the **MENU** button until the acoustic alarm gets mute, then release the button.
5. The balance returns to normal weighing conditions.

19 Selection of working mode with Tablet



NOT available for balance omologate and version software RL 3.xx and R 3.xx.

Using the appropriate connection box, connect the tablet to the serial output of the balance.

1. From condition of zero on display, press and hold the **MENU** button until the acoustic signal is over, then release the button. The message “**unitS**” is displayed, press the button **MENU** until the message “**TBL MODE**” is displayed and confirm pressing **PRINT** button

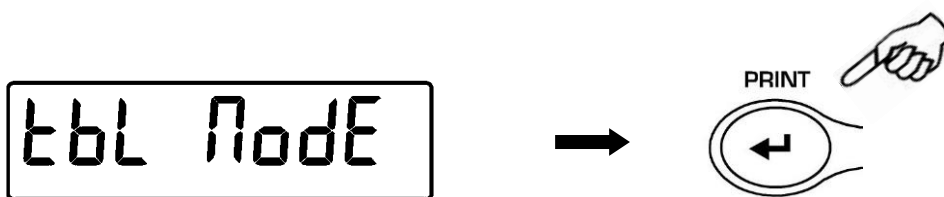

2. To choose the working mode with tablet, press the **MENU** button until you visualize the message “**TBL ON**”, then press **PRINT** to confirm

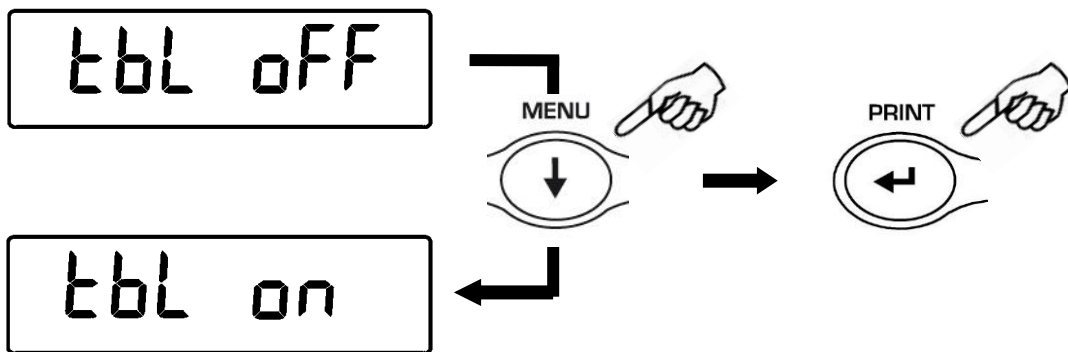

3. After you have chosen the mode “**TBL ON**” the balance will automatically restart and the message “**TABLET**” will appear on the display of balance. From this moment the interface device with the balance is the tablet.

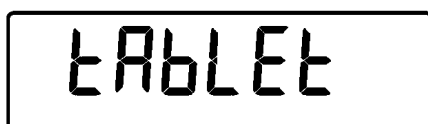

4. To escape from “**TABLET**” mode, press the **MENU** button , then **PRINT** button.

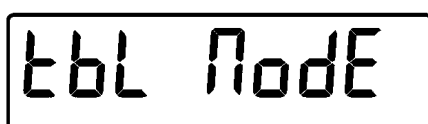

5. Press the **MENU** button until you visualize the message “**TBL OFF**” , then press **PRINT** to confirm the selection.

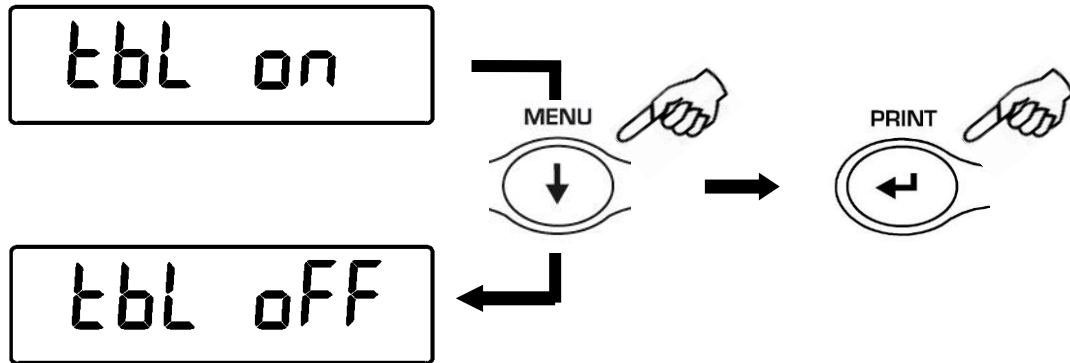

6. After you confirm with the **PRINT** button, the balance will restart automatically and will return to standard working mode.

20 Piececounting function

1. From zero condition on display, press **MENU** button until the message “**Count** “ is displayed then press the **PRINT** button to confirm



2. Select the number of pieces to put on the pan as sample by pressing **MENU** repeatedly to increase and **CAL** to decrease the number. Choice of the number of pieces (10, 25, 50, 100) depends from the weight of single pieces. If available, load the empty container first then press **PRINT** to confirm. Load on the pan the number of pieces displayed on the balance display



Press again the **PRINT** button and wait the weight to stabilize.

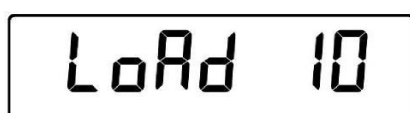

If the number of samples is enough (for example 10 as in figure), then this number will be displayed and it will be possible to go on by loading the pieces to count on the balance pan.



If the weight of the pieces to count is too low in comparison with balance resolution, then an error message will be displayed. In this case it is necessary to use a balance with higher resolution.

If the weight of samples is acceptable but not enough, then the message “**Add**” will be displayed.

Add a quantity of pieces so that to almost double the number read on display, then press the **PRINT** button

If the number of pieces is still not enough then the message “**Add SMP**” is displayed. Add again a quantity of pieces so that to almost double the number you read on display



As soon as it is reached a sufficient number of pieces, this number is displayed and it will be possible to go on with count by loading the pieces count on the balance pan.



3. To escape from piececounting mode press the **ON/OFF** button and the balance returns to normal weighing conditions.

20.1 Visualization of total and unit weight of pieces

1. Press **MENU** button to pass from pieces number visualization to total weight visualization.

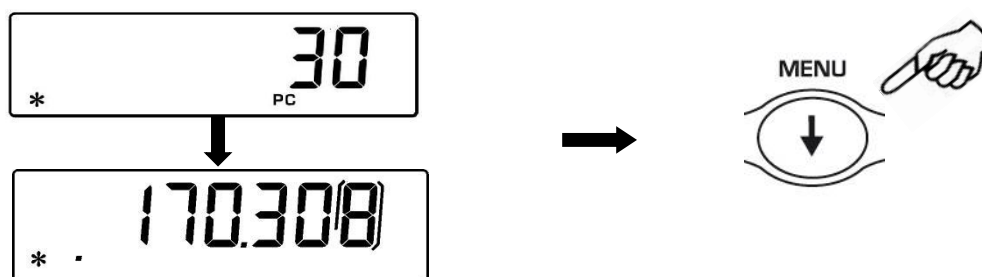

2. In order to display the weight of single piece from the total number of pieces press and keep pressed the **MENU** button until the acoustic alarm gets mute.
3. Press again the **MENU** button to display the number of pieces.

20.2 Manual insertion of the unit average weight

It is possible to insert the unit average weight of the sample, if known. In this way can be avoided the sampling of the units.

1. From zero condition on display, press the **MENU** button until the message “**Count**”, then press the **PRINT** button to confirm.
Select **MANUAL** by pressing repeatedly the **MENU** button.



2. Press the **PRINT** button to confirm.



3. Insert the unit weight of a sample in grams using **CAL** and **MENU** buttons for increase and decrease the value and use the **O/T** button to skip to the others digits. For inserting the decimal point keep pressed the **CAL** button. Keeping pressed the **O/T** button is possible to delete the inserted value.

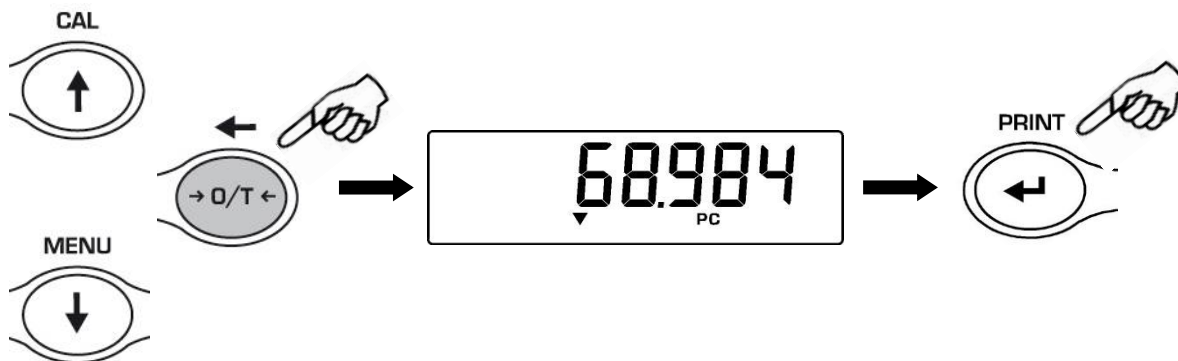

4. Press the **PRINT** button to confirm.
If the inserted weight is 100 times lower than balance resolution, it will be displayed an error message.
To escape without inserting the weight press **ON/OFF**.
5. If the weight is enough then “0” is displayed ; it is now possible to go on to count loading the pieces on the pan.
6. Press **MENU** button to display the total number of pieces, then press again the button to display again the number of pieces.
7. To escape from piececounting function, press **ON/OFF** button.

It is possible to use the optional alphanumeric keyboard to insert the weight of the unit sample as following:

1. From zero condition on display, press the **MENU** button until the message "**Count**", then press the **PRINT** button to confirm.
Select **MANUAL** by pressing repeatedly the **MENU** button.

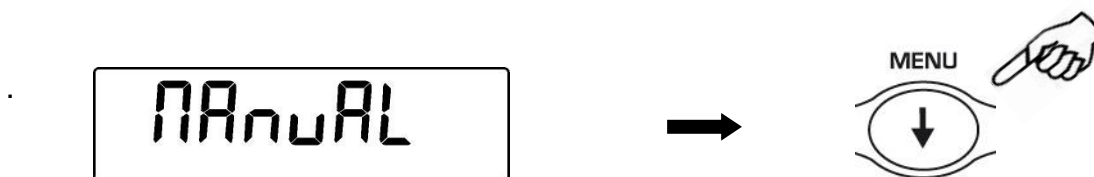

2. Press the **PRINT** button to confirm.
3. Insert the unit weight of a sample in grams using the numerical buttons from 0 to 9 and the decimal point.
In case of mistake, press the **CLEAR** button to start insertion again.
4. Press the **INSER** button to confirm.
5. If the inserted weight is 100 times lower than balance resolution, it will be displayed an error message.
To escape without inserting the weight press **ESCAPE** (on alphanumeric keyboard) or **ON/OFF**.
6. If the weight is enough then "0" is displayed ; it is now possible to go on to count loading the pieces on the pan.
7. Press **MENU** button to display the total number of pieces, then press again the button to display again the number of pieces.
8. To escape from piececounting function, press **ON/OFF** button.

20.3 Automatic update of unit weight

After having effected the sampling, it is possible to update the average piece weight as follows:

1. Instead of loading all the pieces to count, load a number of pieces equal to the double of the ones loaded on the pan and wait for the acoustic alarm.
2. It is now possible to repeat this procedure up to a maximum of 255 pieces or to proceed to the normal counting of the pieces.
This procedure allows a more accurate evaluation of the average unit weight and a better precision in the pieces count.

NOTE: automatic update is not active if the sampling has been effected by insertion of the average unit weight

21 Density determination of a solid or a liquid

* The balance must be equipped with the proper optional software (not available for all models) *

The software for density determination allows to calculate the density of a solid or a liquid through the under balance hook or through the optional hydrostatic kit (cod. T027)

21.1 Density determination of a solid

1. From zero condition on display, press the **MENU** button until the message “**dEnS**” is displayed, then press the **PRINT** button to confirm.

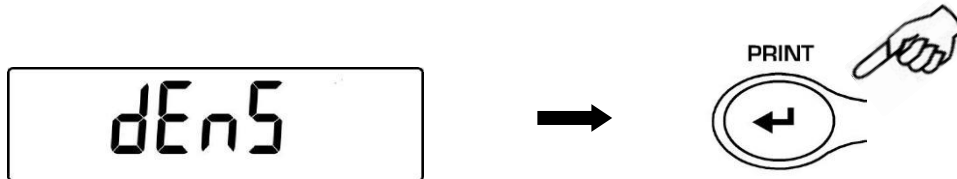

2. Select the function “**d SoLid**” through the MENU button and then confirm with **PRINT** button.

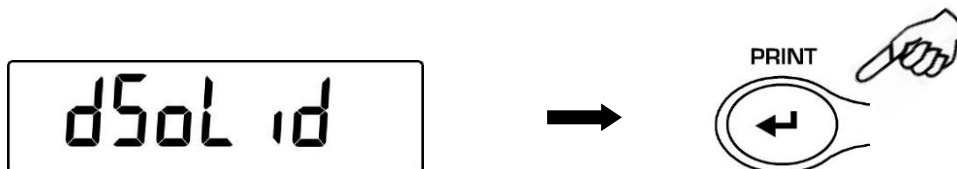

3. The density of the liquid to use will be displayed, the default value is equal to 1.0000 (distilled water at 20°C).

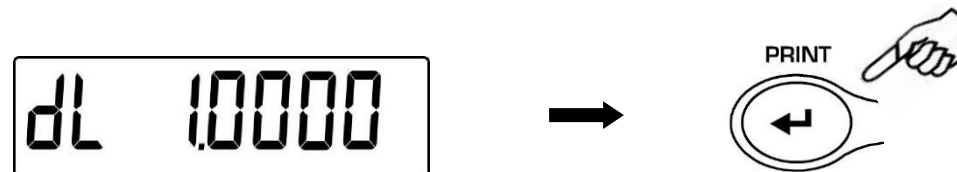

4. It is possible to set a different value using the **CAL** e **MENU** buttons for increase and decrease the value and using the **O/T** button for skip to the others digits. Keeping presses the O/T button is possible to delete the inserted value.

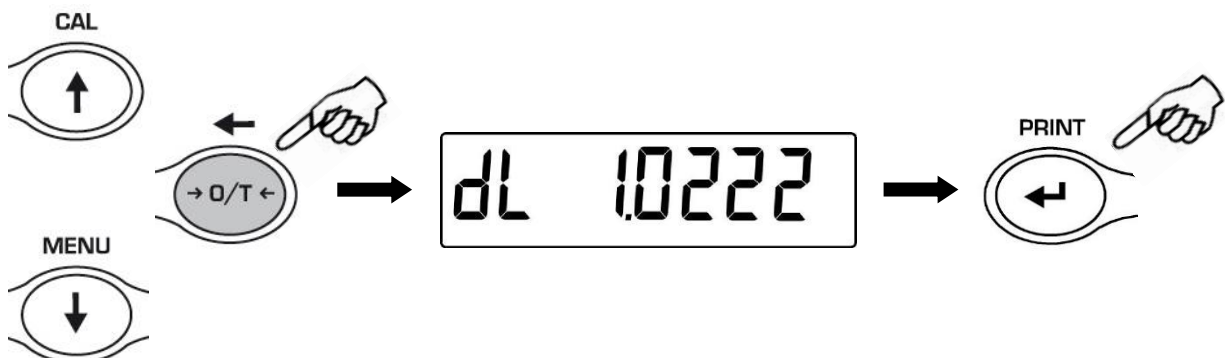

- It is also possible to set a different value if the balance is equipped with the optional alphanumeric keyboard.
- Once the wished value is set, press **PRINT** button.
- Now it will be asked to weigh the solid in air, confirm this with **PRINT** button.

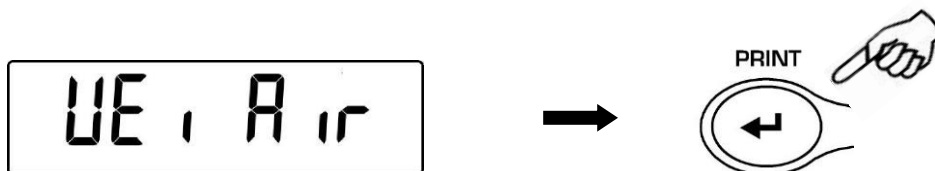

- If necessary, effect a tare operation and load the solid. Press the **PRINT** button to acquire the value. During value acquisition the message **WEI AIR** will be flashing.
- Now it is asked to weigh the solid inside the liquid. Effect the tare of the small basket inside liquid, immerse the solid and press **PRINT**. During the acquisition of the value the message **WEI LIQ** will be flashing.

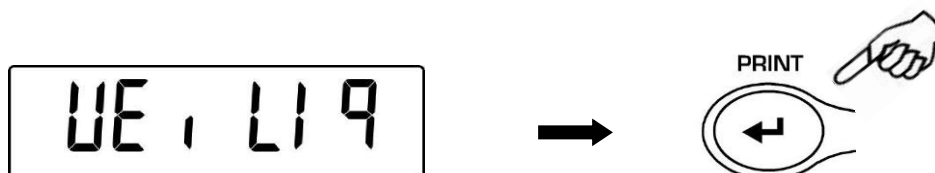

- The result of density of the solid is then displayed. Pressing the **PRINT** button it is possible to print the value of density, if the balance is equipped with a printer.



- If any error occurs, this message will be displayed:

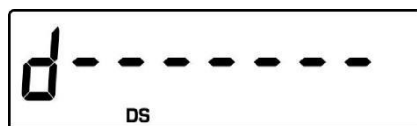

- Press now the **ON/OFF** button to escape from density function or the **MENU** button to perform another measurement.

21.2 Density determination of a liquid

1. From zero condition on display, press the **MENU** button until the message “**dEnS**” is displayed, then press the **PRINT** button to confirm.

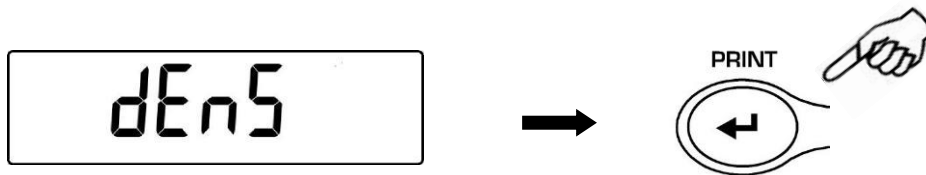

2. Using the **MENU** button, select the function “**d Liquid**” and confirm this with **PRINT**

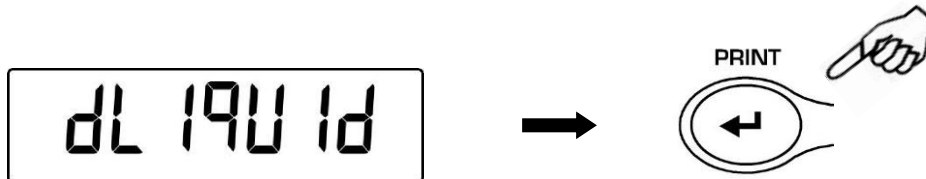

3. It will be displayed the value of the density of the glass float of known volume to use, the default value is equal to 3.0000.

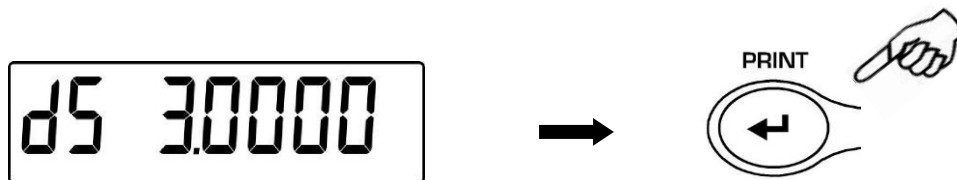

4. It is possible to set a different value using the **CAL** e **MENU** buttons for increase and decrease the value and using the **O/T** button for skip to the others digits. Keeping pressed the **O/T** button is possible to delete the inserted value.

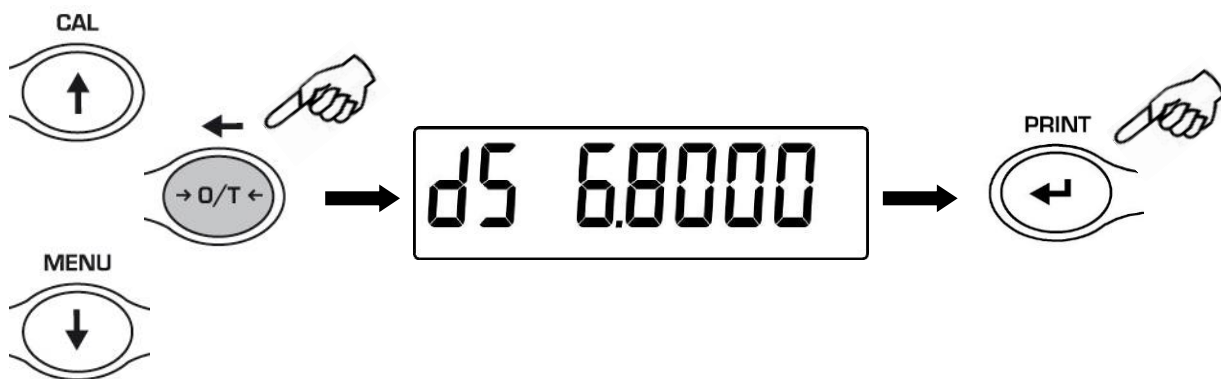

5. It is possible to set a different value if you have the optional alphanumeric keyboard
6. Once the wished value is set, press the **PRINT** button.

7. It is now asked to weigh the glass float in air, confirm this with **PRINT**

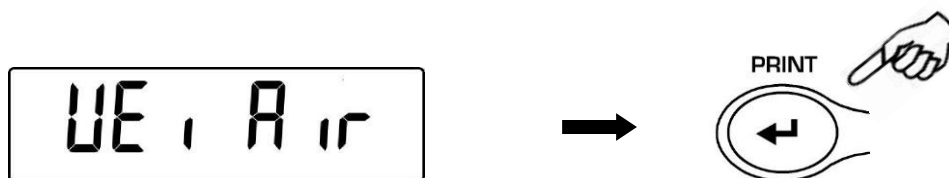

8. Now perform a tare if necessary and put the glass float to the weighing hook. Press then the **PRINT** button to acquire the value. During the acquisition of the value the message **WEI AIR** will be flashing.

9. It is now asked to weigh the glass float immersed into the liquid. Perform a tare if necessary and immerse the glass float into the liquid. Press the **PRINT** button. During the acquisition of the value the message **WEI LIQ** will be flashing.

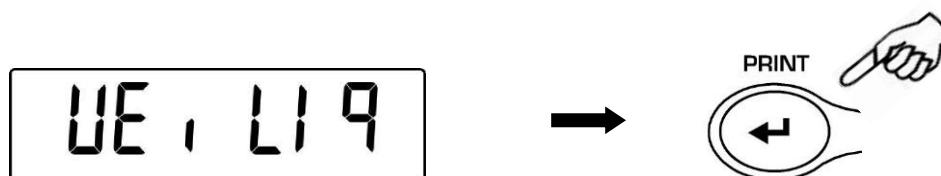

10. The result of the density of the liquid is now displayed. Pressing the **PRINT** button it is possible to print the value of density, if the balance is equipped with a printer.



11. In case of error the following message is displayed

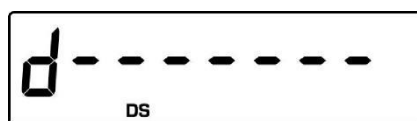

12. Press the **ON/OFF** button to escape from density function, or the **MENU** button to perform another measurement.

22 Maximum load determination function

The balance must be equipped with the specific optional software (not available for all models)

The function **M LOAD** allows to measure the maximum load for a solid.

1. To activate the function M LOAD from zero display condition, press repeatedly the **MENU** button until the message “**M Load**” is displayed, then press the **PRINT** button to confirm. When this function is activated, a tare is automatically performed.

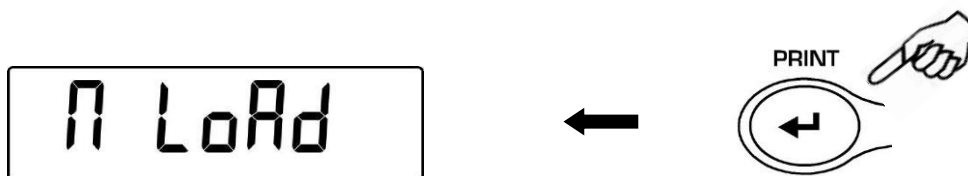

2. Activation of this function is indicated by the visualization of the letter **M** on the last digit on the display.



3. It is now possible to determine the weight of the maximum load.



4. Then press the **TARE** button to effect another measurement.

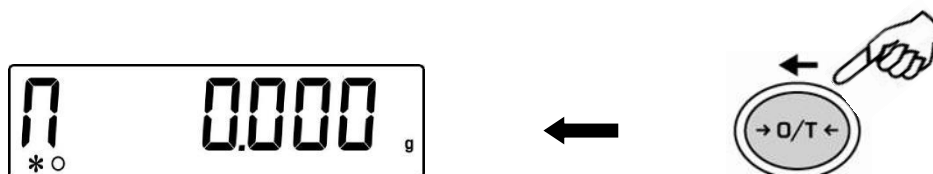

5. When the function **M LOAD** is active, the calibration is disabled.
6. Press the button **ON/OFF** to escape from **M LOAD** function.

23 Percentage weighing function

This function allows to read the weighing value as a percentage of a reference weight. The reference weight is taken as 100% percentage value (factory setting).

There are two modes for acquiring the reference weight: one is automatic (with the reference weight) and one manual (by inserting manually the value of the reference weight).

23.1 Mode with weight reference

1. From zero condition of the display press the **MENU** button until will be displayed the “Perc” message, then press the **PRINT** button to confirm.

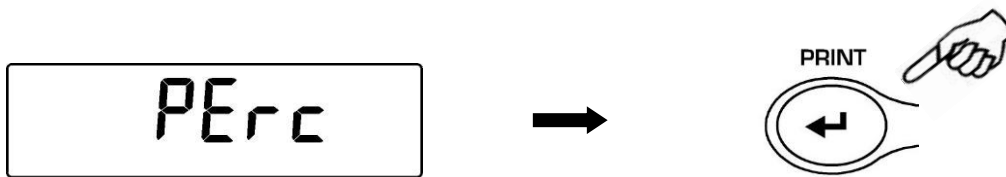

2. Press the MENU button to select the “Perc A” function and press **PRINT** button to confirm.

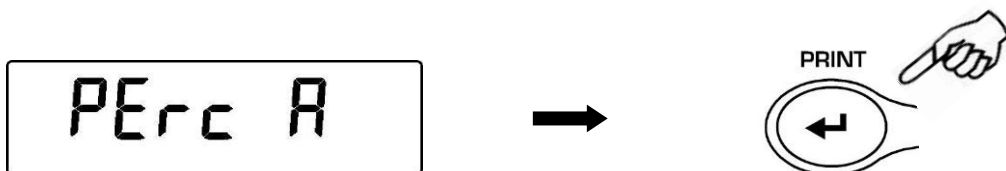

3. Tare function will be performed and will be shown on the display the string “Load”. Then load on the weighing pan the reference and press the **PRINT** button, the string “Load” will start to flash and once the weight is acquired will be visualized the value with the % indication.

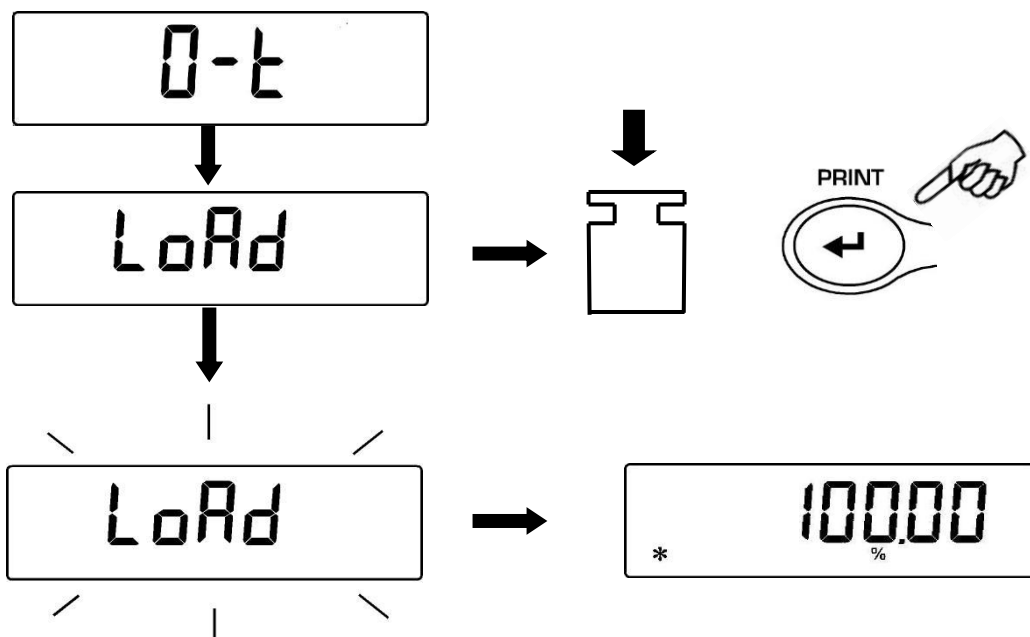

- Remove now the reference weight and load the sample. Is possible to read the weight in percentage now.
- Press the **MENU** button to visualize the weight in gram and vice-versa.

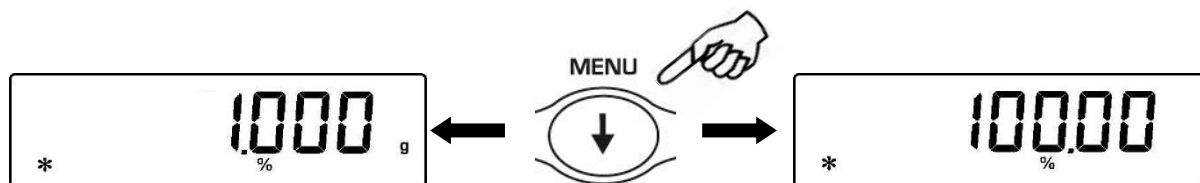

- Press the **ON/OFF** button to escape from the percentage weight function.

NOTE: If the reference weight is lower than 10 digits after the acquiring sequence of the weight, the string **ERROR 07** will be displayed.

23.2 Mode with manual insertion of the reference weight.

- From zero condition of the display press the **MENU** button until will be displayed the **"Perc"** message, then press the **PRINT** button to confirm.



- Press the **MENU** button to select the **"Perc A"** function and press **PRINT** button to confirm.

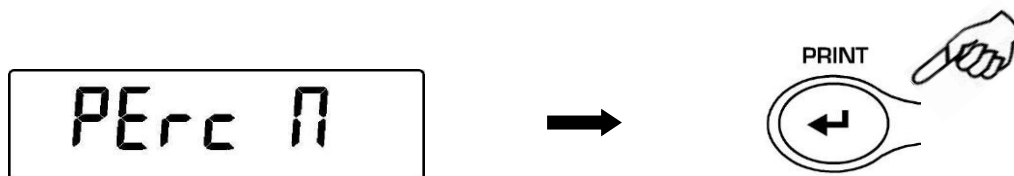

- It is possible to set a different value using the **CAL** e **MENU** buttons for increase and decrease the value and using the **O/T** button for skip to the others digits. Keeping pressed the **O/T** button is possible to delete the inserted value. The inserted value will be stored in the memory until the balance is switched off.



4. Press **PRINT** button when the desired value of the reference weight is inserted
5. Load now the sample and read the percentage value.

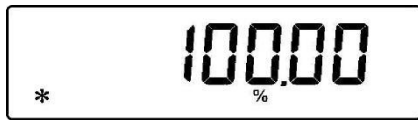

6. Press the **MENU** button to visualize the weight in gram and vice-versa.

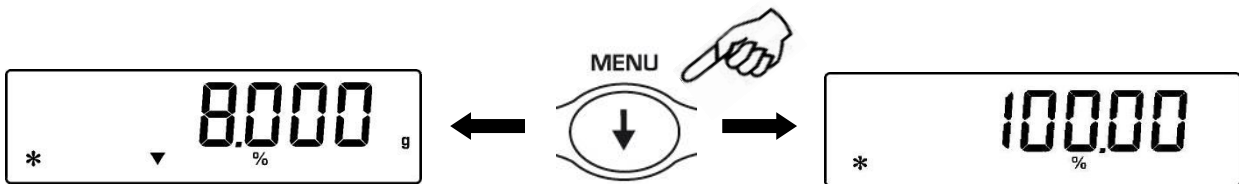

7. Press the **ON/OFF** button to escape from the percentage weight function.
8. It is also possible to set the value if the balance is equipped with the optional alphanumeric keyboard. Press PRINT button to confirm the inserted value.

NOTE: If the reference weight inserted is lower than 10 digit displayed, will be shown the **ERROR 07**.

24 Animal weighing function

This function allows to acquire the averaged weight of moving objects or animals for a time period that can be set.

1. From zero condition of the display press the **MENU** button until will be displayed the “anim UEi” message, then press the **PRINT** button to confirm.

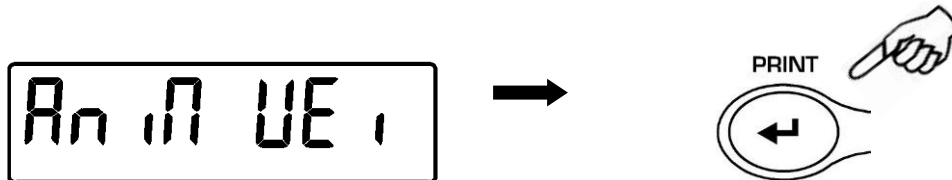

2. Set the desired period time from 5 to 90 sec. using the button **MENU** to decrement and **CAL** to increment time. Confirm by pressing the **PRINT** button.

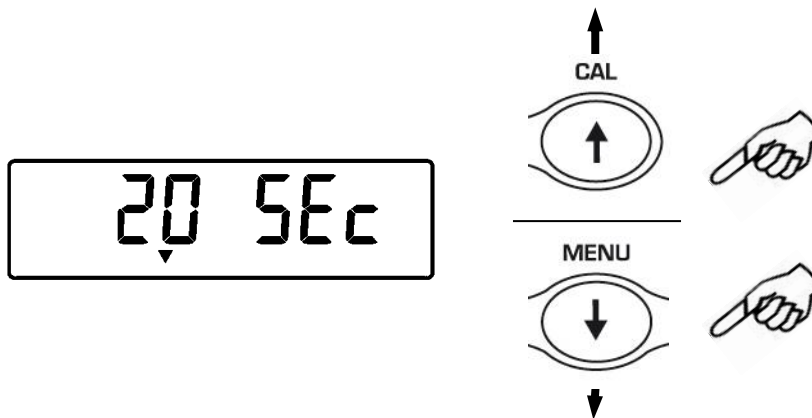

3. It is now displayed the value of current weight, effect tare if necessary, then load on the pan the sample to weight and press the **PRINT** button

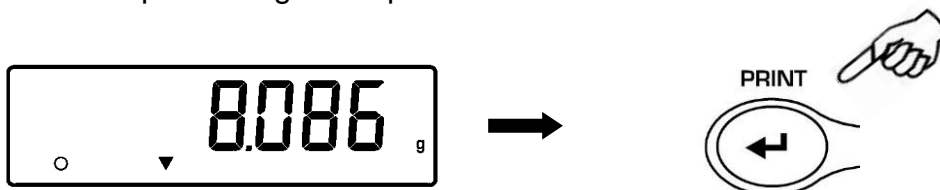

4. It is then displayed the count-down of the sampling time value that has been previously set.
5. When the count-down is finished, it is calculated and then displayed the value of the averaged weight measured.

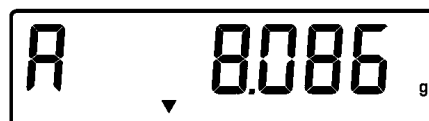

6. Press once the **ON/OFF** button to start another measurement, or twice to escape this function and return to weighing mode

25 Totalizing

This function allows to effect sum of consecutive weighings.

1. From zero condition of the display press repeatedly the **MENU** button until will be displayed the “**add**” message, then press the **PRINT** button to confirm.

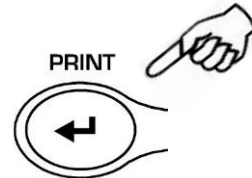

2. The Tare is automatically effected.



3. Load the first weight to sum.

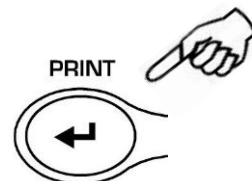

4. Confirm with the **PRINT** button.
5. The Tare is again effected.

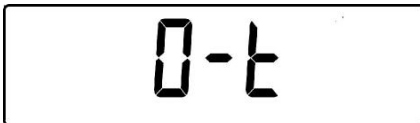

6. Load the second weight to sum.

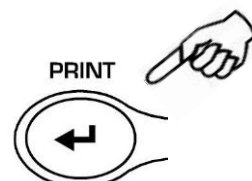
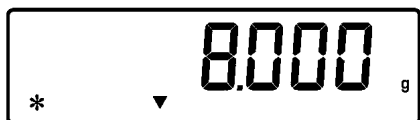

7. Confirm with the **PRINT** button. Follow all the above steps for all weights to sum up to a maximum number of 99.
8. Pressing the **MENU** button it is possible to show in sequence the informations respectively of total weight, number of weighings effected and current weight.

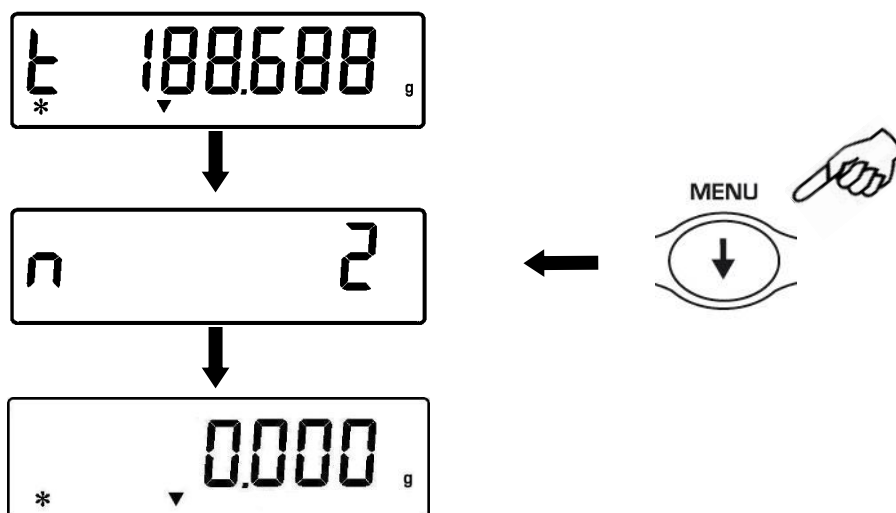

Before the output function:

If the balance is equipped with a printer or connected to a PC, automatically after pressing the print button, will be printed or sent to PC the weigh number and its value. After running all the desired weighs, press CAL to print or send to the PC the value of the total weight. The count of the weighings will then be reset and it will be possible to start over a new measure.

Press the **ON/OFF** button to escape this function and return to weighing mode

26 Threshold function

Threshold function allow to determinate if the weight loaded on the pan is above or below the two threshold fixed by the user.

1. From zero condition of the display press the **MENU** button until will be displayed the string “**H o L**”, then press the **PRINT** button to confirm.

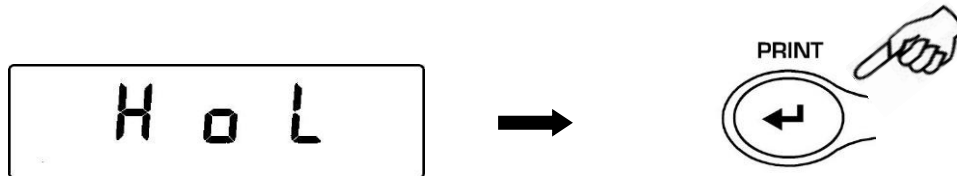

2. Insert the lower threshold value using the **CAL** e **MENU** buttons for increase and decrease the value and using the **O/T** button for skip to the others digits. Keeping pressed the **O/T** button is possible to delete the inserted value. The inserted value will be stored in the memory until the balance is switched off.

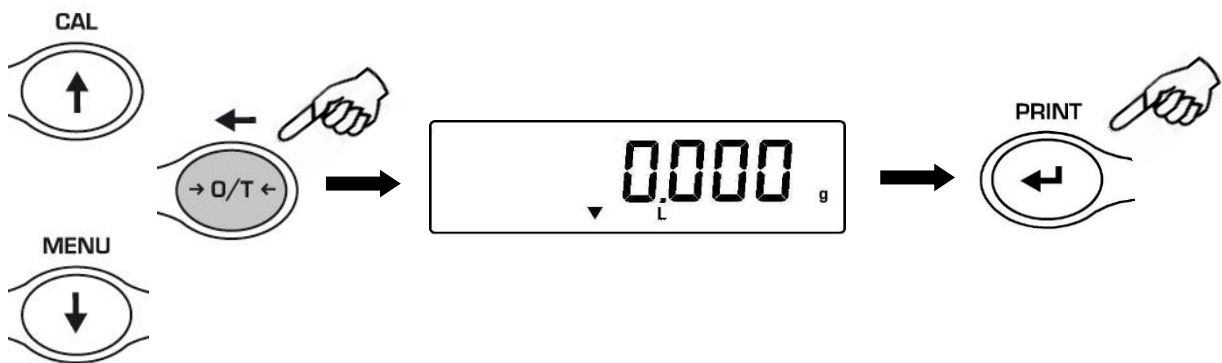

3. Insert the higher threshold value as same as the lower value steps.
4. The string “**bEEP OFF**” will be displayed and select by the **MENU** button if the acoustic alarm should be set or not if the weight is within the two threshold values set before. Press **PRINT** button to confirm.

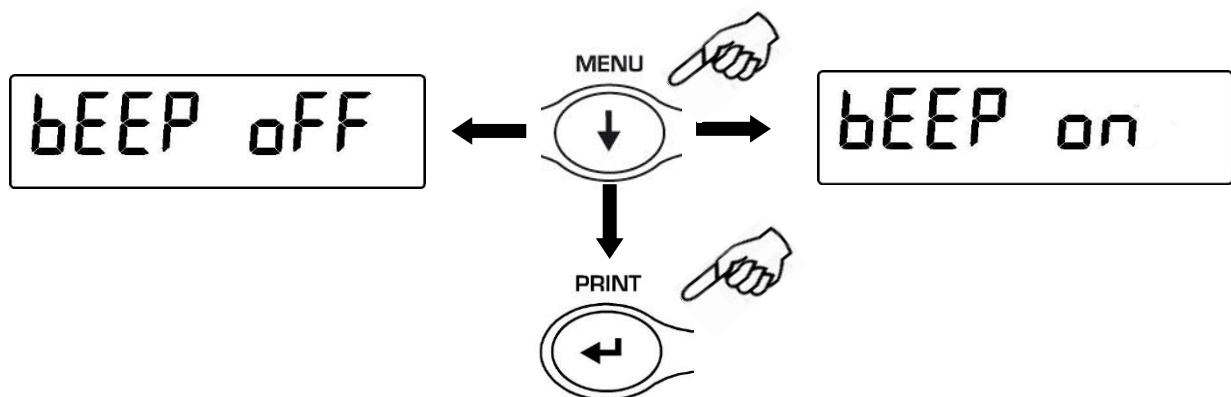

5. If the value of the thresholds is correctly inserted, the balance will be back to the weighing mode with the indication of the threshold state (H = higher threshold, L = lower threshold, OK= weight within the two set thresholds).

NOTE: If the values are not inserted correctly will be displayed the string ERROR 07.

There are 3 modes of the threshold function:

26.1 Both thresholds set

This mode allow to set the lower and the higher threshold values and to identify the acceptable range for the weight value shown by the switching on of the symbol "OK" and by the acoustic alarm is activated. When the value of the weight is under the lower threshold value set will be displayed the symbol " L " while if the weight is over the higher threshold value set will be displayed the symbol " H " .

26.2 Lower threshold set only

Setting only the lower threshold and setting to zero the higher threshold, will be displayed the symbol "OK" and eventually the acoustic alarm if activated whenever the loaded weight is higher than the lower threshold value set. When the value of the weight is under the lower threshold set the symbol " L " will be displayed.

26.3 Higher threshold set only

Setting only the higher threshold and setting to zero the lower threshold, will be displayed the symbol "OK" and eventually the acoustic alarm if activated whenever the loaded weight is lower than the higher threshold value set. When the value of the weight is above the higher threshold set the symbol " H " will be displayed.

27 RS232 interface features

1. General features

The balance transmits the value visualized on the display following serial RS232C standard, allowing to print the value of weight to a PC monitor or to a serial printer. In the case of connection to a PC, it will be possible to select the transmission in continuous mode or transmission at user command through pressing of the **PRINT** button (as described at par.10). The balance is also capable of receiving commands, always through the standard RS232C, that allow performing all the functions available through the keyboard of PC itself. The speed of transmission and reception can be selected, as described previously (see par.12), to 1200, 2400, 4800, e 9600 baud. The character format is of 8 bit preceded by one bit of start and followed by a bit of stop. Parity is not considered.

2. Selection of interface for PC

Selecting the transmission to PC (personal computer IBM compatible), it is achieved a continuous transmission output, at the same rate of weight update on display of the balance. It is possible to perform all the functions of the balances directly from the computer keyboard, transmitting to the balance the ASCII codes as in the table below. The connector to use for connection to PC is the number 2 with reference to

CODE	1 st FUNCTION (SINGLE PRESS)
"T" = H54	TARE
"C" = H43	CALIBRATION
"E" = H45	ENTER
"M" = H4D	MENU
"O" = H4F	ON/OFF

fig.2 of paragraph 5 of this manual.

CODICE	2 nd FUNCTION (PROLONGED PRESS)
"t" = H74	TARE
"c" = H63	CALIBRATION
"e" = H65	ENTER
"m" = H6D	MENU
"o" = H6F	ON/OFF

Selecting the transmission to PC at user command, it is achieved a transmission output only when the **PRINT** button is pressed, also in this case it is possible to perform all the functions of the balance directly from the keyboard of the computer, sending to the balance the ASCII codes in the table above.

3. Connection of the balance to PC

To receive/transmit data, link the connector (n.2 of fig.2 at par.5) of the balance to the serial port of your Personal Computer as shown below:

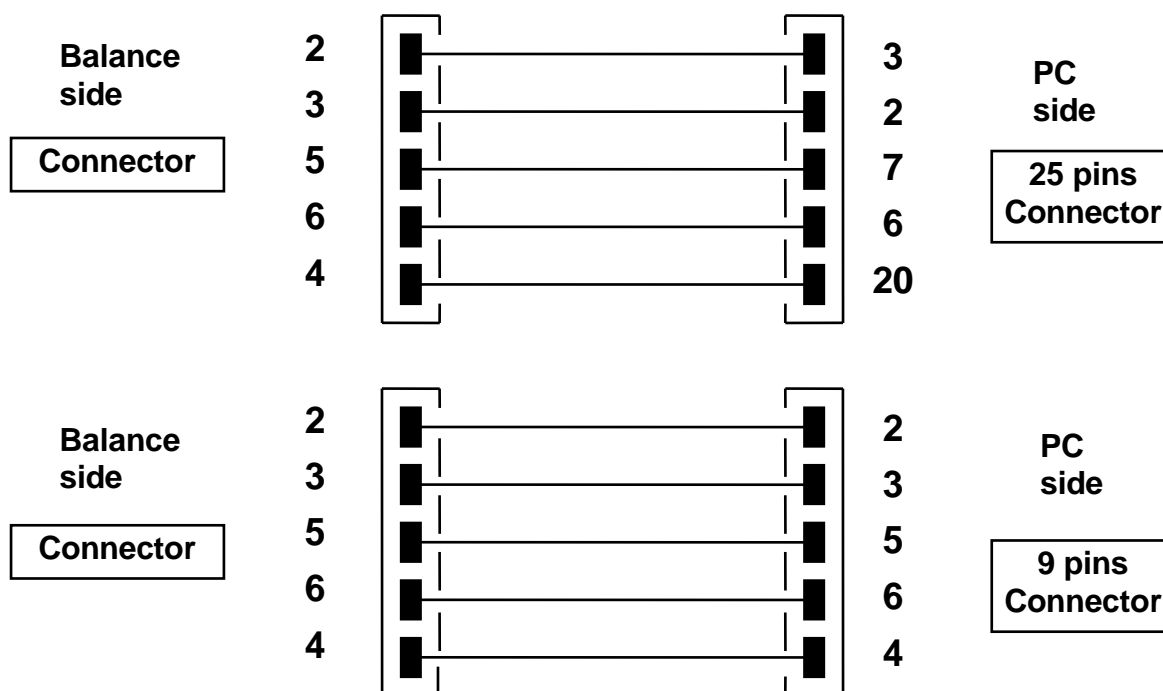

4. Transmission format

String transmitted is composed by the following 14 characters:

- First character: weight sign (blank or -)
- second/ninth character: weight or other data
- tenth/twelfth character: weight unit symbol
- thirteenth character: stability indicator
- fourteenth character: carriage return
- fifteenth character: line feed

Eventual non-significative zero are put as spaces.

In the following tables the various transmission formats are shown:

Weighing mode (valid both for continuous transmission and transmission at user command)

1°	2°	3°	4°	5°	6°	7°	8°	9°	10°	11°	12°	13°	14°	15°
Sign	Weight							Weight unit			Stability	CR	LF	

Density mode (only in transmission at user command mode)

1°	2°	3°	4°	5°	6°	7°	8°	9°	10°	11°	12°	13°	14°	15°	16°	17°
d	=	Density value				Space	Weight unit					CR	LF			

Piececounting mode (only in transmission at user command mode)

Number of pieces

1°	2°	3°	4°	5°	6°	7°	8°	9°	10°	11°	12°	13°	14°	15°	16°	
Pcs			:	spaces				Number of pieces								

Total weight of pieces

1°	2°	3°	4°	5°	6°	7°	8°	9°	10°	11°	12°	13°	14°	15°	16°	17°	18°	19°	20°
Weight						:	space	Value of weight								space	g	space	S

Average unit weight of pieces:

1°	2°	3°	4°	5°	6°	7°	8°	9°	10°	11°	12°	13°	14°	15°	16°	17°	18°
PMU		:	spaces				Value of weight									spaces	g

PMU stands for average unit weight

Percentage weight mode (only in transmission at user command mode)

Percentage

1°	2°	3°	4°	5°	6°	7°	8°	9°	10°	11°	12°	13°	14°	15°	16°	17°	18°
Perc			.	space				Percentage								space	%

Weight

1°	2°	3°	4°	5°	6°	7°	8°	9°	10°	11°	12°	13°	14°	15°	16°	17°	18°
Weight						space	Weight value								space	g	

Animal weighing mode (only in transmission at user command mode)

Time

1°	2°	3°	4°	5°	6°	7°	8°	9°	10°	11°	12°	13°	14°	15°	16°	17°	18°
----	----	----	----	----	----	----	----	----	-----	-----	-----	-----	-----	-----	-----	-----	-----

Time	space	=	space	Time value	Sec	space
------	-------	---	-------	------------	-----	-------

Averaged Weight

1°	2°	3°	4°	5°	6°	7°	8°	9°	10°	11°	12°	13°	14°	15°	16°	17°	18°
Ave	.	=	space	Averaged weight value										space	g		

Totalizing (only in transmission at user command mode)

Weighing

1°	2°	3°	4°	5°	6°	7°	8°	9°	10°	11°	12°	13°	14°	15°	16°	17°	18°
Weighing number	.	space	Value of weight										space	g			

Weighs total

1°	2°	3°	4°	5°	6°	7°	8°	9°	10°	11°	12°	13°	14°	15°	16°	17°	18°
S	space	=	space	Value of weight										space	g		

Threshold function (only in transmission at user command mode)

1°	2°	3°	4°	5°	6°	7°	8°	9°	10°	11°	12°	13°	14°	15°	16°	17°	18°	19°	20°
Weight							:	minus si ng if negative	Value of weight							space	g		

If Low

1°	2°	3°	4°	5°
- Low -				

Else High

1°	2°	3°	4°	5°
- High -				

Else Ok

1°	2°	3°	4°	5°
- Ok -				

5. Selection of interface to printer

Selecting the PRINTER mode, the serial output of the balance is set to work with serial printers.

In this case the printing is effected only when the **PRINT** button is pressed and with stable weight. If the stability is not reached within ten seconds, the message **ERR05** is displayed preceded by a short acoustic signal and the value of the weight is not sent to the printer.

6. Connection of the balance with the serial printer

Connect a serial printer to the connector (n.2 of fig.2 at par.5) to the balance as shown in the following scheme:

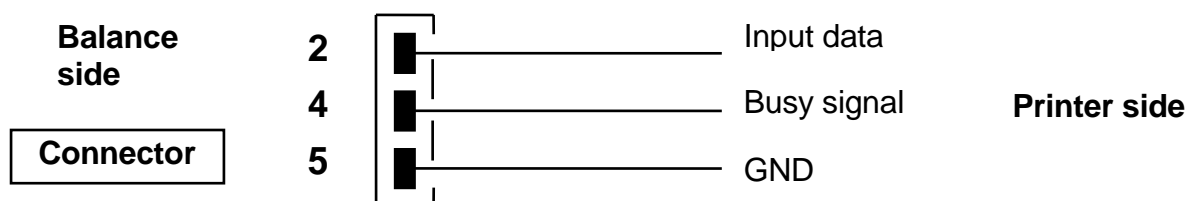

If the optional TLP50 printer is used, it will be possible to print both in *continuous-mode* and in *labels-mode* with the following formats:

Weighing mode and maximum load mode

12-02-2008	12:00
Weight:	22.000 g

Piececounting mode

12-02-2008	12:00
Pcs	100
Weight:	300.000 g
PMU:	3.000 g

Density determination mode

12-02-2008	12:00
d=	2.80066 g/cm ³ d

Percentage weight mode

12-02-2009	12:00
Perc.	100.0%
Weight:	300.000 g

Animal weighing mode

12-02-2009	12:00
Time =	6 Sec
Ave. =	59.446 g

Totalizing (sum of weights) mode

12-02-2010	12:00
1.	16.589 g
2.	17.226 g
...	
99.	

S=	33.815 g

Threshold function

12-02-2013	12:00
Weight: 0.00g	
-LOW-	

12-02-2012	12:00
Weight: 49.20g	
- OK -	

12-02-2011	12:00
Weight : 249.42g	
-HIGH-	



7. Connection of the balance to the optional alphanumeric keyboard

To connect the optional external alphanumeric keyboard to the balance, it must be used the same connector that is used to link the balance to PC. In this case the connection to PC or to printer must be effected through the connector placed on the optional alphanumeric keyboard.

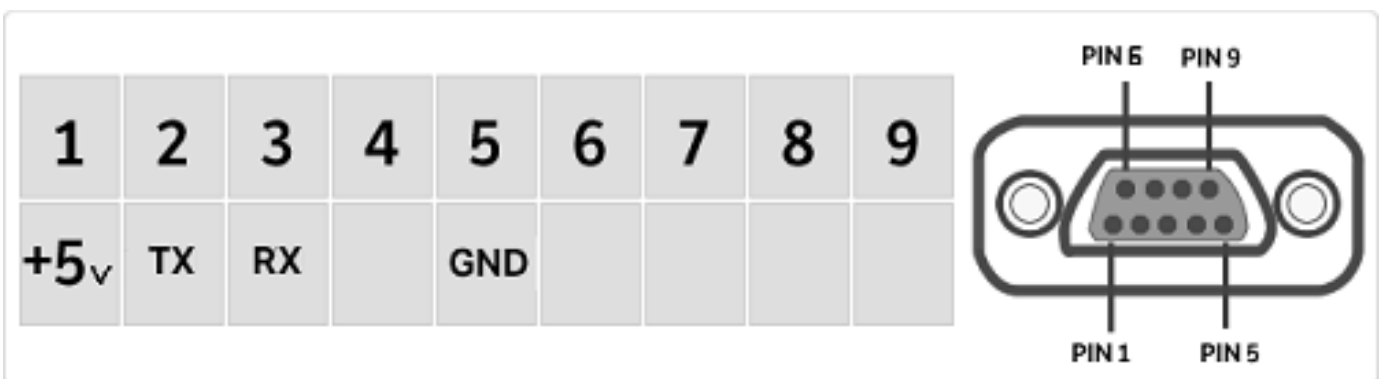
8. Map of RS232 interface Connector



28 Error codes

ERROR MESSAGE ON DISPLAY	MEANING	POSSIBLE SOLUTIONS
ERR01	Weight not stable after operation of tare	Protect the balance from air flows or from vibrations of the working table
ERR02	impossible to start the calibration due to instability of the balance	Protect the balance from air flows or from vibrations of the working table.
ERR03	calibration weight not correct or balance unstable	Calibrate with correct weight or protect the balance from environment disturbs
ERR04	weight of samples for the piececounting function not adequate or unstable	Select a bigger number of samples or protect the balance from vibrations.
ERR05	impossible to print / weight unstable	Protect the balance from environment disturbs
ERR06	Weight cannot get stable in density mode	Protect the balance from environment disturbs
ERR07	error in inserting the data	
ERR08	Anomaly on autocalibration motor	Contact service staff
“UNLOAD”	weight loaded on the pan or pan not positioned properly	Remove the weight from the pan or position properly the pan and underpan.
“CAL But”:	the balance requires to be re-calibrated	Unload weights, if any, on the pan, and press the CAL button
	Over-range condition	Unload the weights loaded on the pan
	Under-range condition	Place properly pan and underpan

29 Maintenance and care

Regular maintenance of yours balance guarantee accurate measurements.

1) Cleaning

Before cleaning the balance unplug the power supply of the balance from the voltage supply of your room. Do not use aggressive cleaning product (as solvents or similar), use a humid towel with soft detergent, Avoid liquids to go inside the instrument during the cleaning. Wipe the balance with a soft towel. Parts of samples or powder can be removed using a brush or vacuum cleaner.

2) Safety Checks

Safety of the instrument is no more guaranteed when:

- balance power supply is clearly damaged
- balance power supply is not working anymore
- balance power supply is stored for long time in hard environment conditions.

In these instances refer to the assistance centre where specialized technician will make reparations to bring back the instrument in the safety conditions eventually.

30 Quick guide to balance parameters setup

- To enter the balance parameters setup menu, press and keep pressed the **MENU** button until the acoustic alarm gets mute.
- Use then the **MENU** button to go to next parameter, use the **CAL** button to go to previous and the **PRINT** button to confirm the choice.
- To escape from menu, press and keep pressed the **MENU** button until the acoustic alarm gets mute.

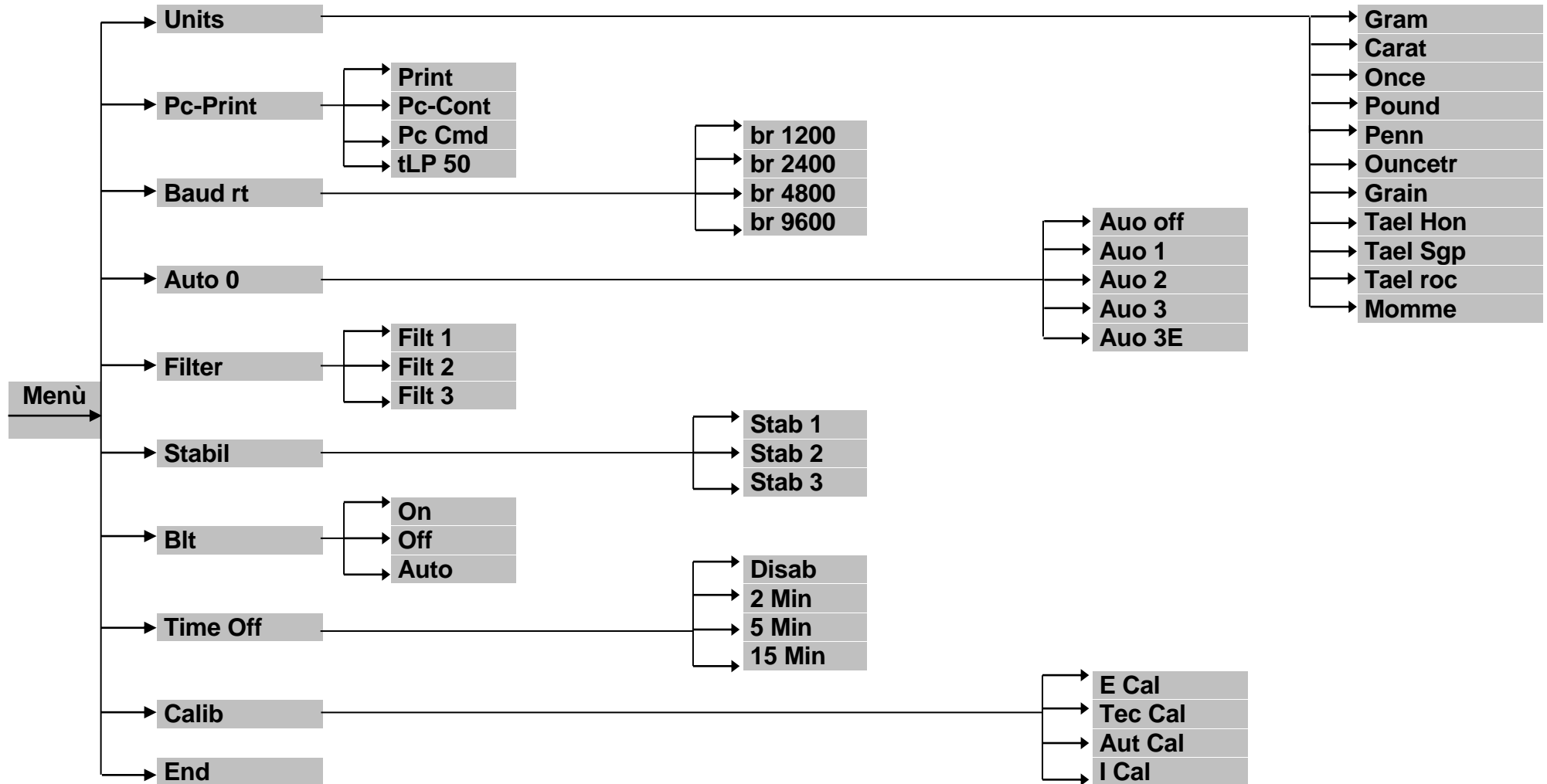

31 Quick guide to the use of the balance programs

- To enter the balance programs menu, press the **MENU** button.
- Use then the **MENU** button to go to next parameter, use the **CAL** button to go to previous and the **PRINT** button to confirm the choice.
- To escape from menu, press and keep pressed the **MENU** button until the acoustic alarm gets mute.

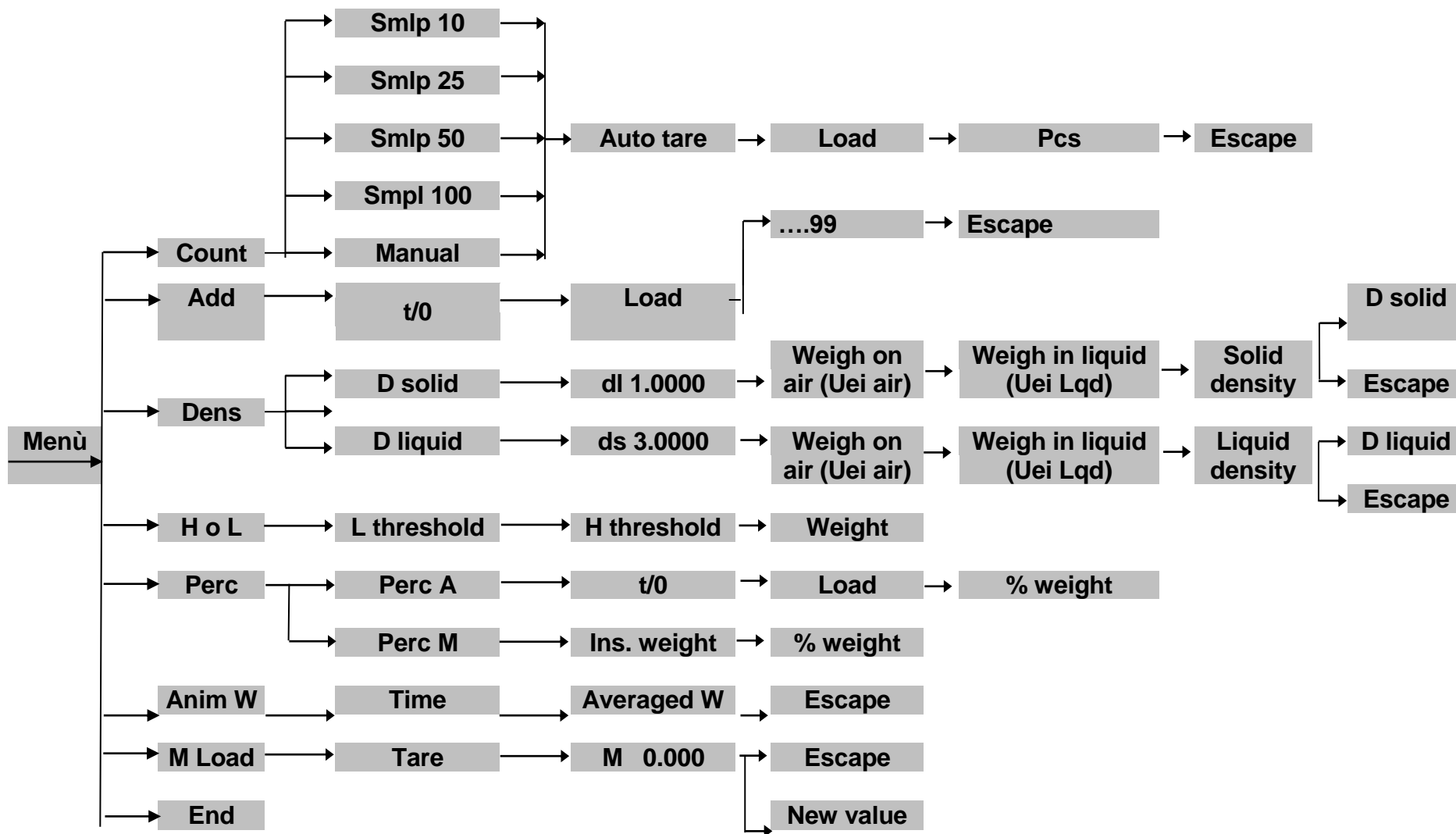

32 Balance Technical features

The models below indicated are all for internal use. Max altitude use: 4000m; Pollution grade: 2; Overvoltage category: II

For models with power supply 24 V:

Power supply included:	INPUT: Switching 100-240Vac~ 50/ 60Hz, OUTPUT: 24V DC 1A, Max absorbed power 13.2VA-
Environment condition adaption:	Selectable filters
Autozero:	Selectable from Menu
Serial output:	RS232C
Operating temperature range:	+5°C - +35°C

For models with power supply 9 V:

Power supply included:	INPUT: Switching 100-240Vac~ 50/ 60Hz, OUTPUT: 9V DC 1A, Max absorbed power 9VA-
Environment condition adaption:	Selectable filters
Autozero:	Selectable from Menu
Serial output:	RS232C
Operating temperature range:	+5°C - +35°C

33 Optional Accessories

ACCESSORIES	
Code	DESCRIPTION
611-2792	Tablet System for balances. Includes Tablet, Tab-box, support, Application. USB version
611-8683	Tablet System for balances. Includes Tablet, Tab-box, support, Application. BLUETOOTH version.
630-1485	TLP-50 Serial Printer, with date/time (connection cable included)
630-1486	TLP-50 Serial Printer, with date/time (connection cable included) Interface UK
611-2794	DPP-250 Serial Printer (can work also with batteries, connection cable included)
611-2793	BLUETOOTH printer DPP-250-BT (works also w/ battery) for Tablet system
630-1488	Roll of paper for TLP-50 printer
630-1487	Roll of 54x24mm labels (500) for TLP-50 printer
611-2795	Roll of paper for DPP250 printer
630-1488	Alphanumeric external keyboard mod. Keymodule
611-2786	RS232/USB CONVERTER
611-2787	Serial cable 9pins M/M for serial output printer/PC
611-2553	Density KIT for solids and liquids for balances 0.001g and 0.0001g
611-2552	Density KIT for solids and liquids for balances 0.01g
611-8684	Portable rechargeable battery pack
611-3446	Ioniser

34 Technical service

Web Resources

Visit the VWR's website at www.vwr.com for:

- Complete technical service contact information
- Access to VWR's Online Catalogue, and information about accessories and related products
- Additional product information and special offers

Contact us For information or technical assistance contact your local VWR representative or visit. www.vwr.com.

35 Warranty

VWR International warrants that this product will be free from defects in material and workmanship for a period of two (2) years from date of delivery. If a defect is present, VWR will, at its option and cost, repair, replace, or refund the purchase price of this product to the customer, provided it is returned during the warranty period. This warranty does not apply if the product has been damaged by accident, abuse, misuse, or misapplication, or from ordinary wear and tear. If the required maintenance and inspection services are not performed according to the manuals and any local regulations, such warranty turns invalid, except to the extent, the defect of the product is not due to such non-performance.

Items being returned must be insured by the customer against possible damage or loss. This warranty shall be limited to the aforementioned remedies. **IT IS EXPRESSLY AGREED THAT THIS WARRANTY WILL BE IN LIEU OF ALL WARRANTIES OF FITNESS AND IN LIEU OF THE WARRANTY OF MERCHANTABILITY.**

36 Compliance with local laws and regulations

The customer is responsible for applying for and obtaining the necessary regulatory approvals or other authorizations necessary to run or use the Product in its local environment. VWR will not be held liable for any related omission or for not obtaining the required approval or authorization, unless any refusal is due to a defect of the product.

37 Equipment Disposal



This equipment is marked with the crossed out wheeled bin symbol to indicate that this equipment must not be disposed of with unsorted waste.

Instead it's your responsibility to correctly dispose of your equipment at lifecycle -end by handling it over to an authorized facility for separate collection and recycling. It's also your responsibility to decontaminate the equipment in case of biological, chemical and/or radiological contamination, so as to protect from health hazards the persons involved in the disposal and recycling of the equipment.

For more information about where you can drop off your waste of equipment, please contact your local dealer from whom you originally purchased this equipment.

By doing so, you will help to conserve natural and environmental resources and you will ensure that your equipment is recycled in a manner that protects human health.

Thank you

Austria

VWR International GmbH
Graumannsgasse 7
1150 Wien
Tel.: 01 97 002 0
Fax: 01 97 002 600
E-mail: info@at.vwr.com

Belgium

VWR International bvba
Researchpark Haasrode 2020
Geldenaaksebaan 464
3001 Leuven
Tel.: 016 385 011
Fax: 016 385 385
E-mail: customerservice@be.vwr.com

Czech Republic

VITRUM VWR s. r. o.
a VWR International Company
Pražská 442
CZ - 281 67 Střibná Skalce
Tel.: +420 321 570 321
Fax: +420 321 570 320
E-mail: info@cz.vwr.com

Denmark

VWR - Bie & Berntsen
Transformervej 8
2730 Herlev
Tel.: 43 86 87 88
Fax: 43 86 87 90
E-mail: info@dk.vwr.com

Finland

VWR International Oy
Valimotie 9
00380 Helsinki
Tel.: 09 80 45 51
Fax: 09 80 45 52 00
E-mail: info@fi.vwr.com

France

VWR International S.A.S.
Le Périgares – Bâtiment B
201, rue Carnot
94126 Fontenay-sous-Bois cedex
Tel.: 0 825 02 30 30 (0,15 € TTC/min)
Fax: 0 825 02 30 35 (0,15 € TTC/min)
E-mail: info@fr.vwr.com

Germany

VWR International GmbH
Hilpertstraße 20a
D - 64295 Darmstadt
Freecall: 0800 702 00 07
Fax: 0180 570 22 22*
Email: info@de.vwr.com
*0,14 €/Min. aus d. dt. Festnetz

Hungary

VWR International Kft.
Simon László u. 4.
4034 Debrecen
Tel.: (52) 521-130
Fax: (52) 470-069
E-mail: info@hu.vwr.com

Ireland / Northern Ireland

VWR International Ltd /
VWR International (Northern Ireland) Ltd
Orion Business Campus
Northwest Business Park
Ballycoolin
Dublin 15
Tel.: 01 88 22 222
Fax: 01 88 22 333

E-mail: sales@ie.vwr.com

Italy

VWR International PBI S.r.l.
Via San Giusto 85
20153 Milano (MI)
Tel.: 02-3320311/02-487791
Fax: 800 152999/02-40090010
E-mail: info@it.vwr.com
info@internationalpbi.it

The Netherlands

VWR International B.V.
Postbus 8198
1005 AD Amsterdam
Tel.: 020 4808 400
Fax: 020 4808 480
E-mail: info@nl.vwr.com

Norway

VWR International AS
Haavard Martinsens vei 30
0978 Oslo
Tel.: 02290
Fax: 815 00 940
E-mail: info@no.vwr.com

Poland

VWR International Sp. z o.o.
Limbowa 5
80-175 Gdansk
Tel.: 058 32 38 200 do 204
Fax: 058 32 38 205
E-mail: labart@pl.vwr.com

Portugal

VWR International -
Material de Laboratório, Lda
Edifício Neopark
Av. Tomás Ribeiro, 43- 3 D
2790-221 Camaxide
Tel.: 21 3600 770
Fax: 21 3600 798/9
E-mail: info@pt.vwr.com

Spain

VWR International Eurolab S.L.
C/ Tecnología 5-17
A-7 Llinars Park
08450 - Llinars del Vallès
Barcelona
Tel.: 902 222 897
Fax: 902 430 657
E-mail: info@es.vwr.com

Sweden

VWR International AB
Fagerstagatan 18a
163 94 Stockholm
Tel.: 08 621 34 00
Fax: 08 621 34 66
E-mail: kundservice@se.vwr.com

Switzerland

VWR International GmbH
Lerzenstrasse 16/18
8953 Dietikon
Tel.: 044 745 13 13
Fax: 044 745 13 10
E-mail: info@ch.vwr.com

Turkey

Pro Lab Laboratuvar Teknolojileri Ltd.Şti.
a VWR International Company
Orta Mah. Cemal Gürsel Caddesi
Ördekcioğlu İşmerkezi No.32/1
34896 Pendik - İstanbul
Tel.: +90216 598 2900

Fax: +90216 598 2907
Email: info@pro-lab.com.tr

UK

VWR International Ltd
Customer Service Centre
Hunter Boulevard - Magna Park
Lutterworth
Leicestershire
LE17 4XN
Tel.: 0800 22 33 44
Fax: 01455 55 85 86
E-mail: uksales@uk.vwr.com

Australia

VWR International, Pty Ltd.
Unit 1/31 Archimedes Place
Murarie, Queensland 4172
Tel.: 1300 727 696
Fax: 1300 135 123

China

VWR (Shanghai) Co., Ltd
2nd Floor, Building 4,
Lane 998, Halei Rd,
Zhangjiang Hi-tech Park
Shanghai, 201203
Tel.: +86-21-5898 6888
Fax: +86-21-5855 8801
E-mail: info_china@vwr.com

India

VWR Lab Products Private Limited
135/12, Brigade Towers, 2nd Floor
Front wing, Brigade Road,
Bengaluru, India – 560 025
Tel.: +91-80-41117125/26 (Bengaluru)
Tel.: +91-2522-647911/922 (Mumbai)
Fax: +91-80-41117120
E-mail: vwr_india@vwr.com

New Zealand

Global Science - A VWR Company
241 Bush Road
Albany 0632, Auckland
Tel.: 0800 734 100
Fax: 0800 999 002
E-mail: sales@globalscience.co.nz

Singapore

VWR Singapore Pte Ltd
18 Gul Drive
Singapore 629468
Tel.: +65 6505 0760
Fax: +65 6264 3780
E-mail: sales@sg.vwr.com

GO TO VWR.COM FOR THE
LATEST NEWS, SPECIAL OFFERS
AND DETAILS OF YOUR LOCAL
VWR DISTRIBUTOR
